

# Works Access Permit

Wellington City Council

Absolutely Positively  
Wellington City Council  
Me Heke Ki Pōneke

Registration Number: R957162

Utility Reference: STH-Generic Minor Excavation

## 1. Details of Proposed Work Activity:

Activity: Open Trenching, Pot Holing, Other (Specify Detail), Hand Digging

Address: 1 Landfill Road, Happy Valley, Wellington, 1, Landfill Road, Happy Valley, Wellington, 6023, 6023

Location in road: Carriageway, Footpath, Berm, Nature Strip

WAP valid period: 10 August 2023 to 08 August 2024

## 2. The Parties

Wellington City Council being a body corporate in accordance with the Local Government Act 2002 ('the Corridor Manager;')

Wellington Water Alliance being an approved Utility Operator in accordance with submitting a request for access in accordance with that act;

Wellington Water Alliance being the agent of the Utility Operator submitting this request on behalf of the Utility Operator and in accordance with the Utility Operator's statutory rights ('the Applicant').

## 3. Attachments

Attachment 1 being the Schedule of Reasonable Conditions.

Attachment 2 being the plan ##### showing the agreed works statement.

## 4. Background

(a) The Utility Operator wishes to carry out the works stated on CAR Number R957162 and thereafter maintain the utility services established in the corridor;

(b) The Corridor Manager is required to provide a written consent in accordance with its governing legislation and to provide a schedule of reasonable conditions, if required, by the utility legislation under which the request for access has been made; and

(c) In accordance with the Code: Utilities' Access to the Transport Corridors and on behalf of the Corridor Manager, I give my written consent for access to the corridor at the agreed location and attach my schedule of reasonable conditions;

(d) In the case of State highways this Works Access Permit serves as the approvals required under sections 51 and 78 of the Government Roding Powers Act;

**It is expected that all the conditions set in the CAR have been read and are followed completely, failure to adhere will result in the cancellation of the (WAP) Work Access Permit.**

\*All Contractors, Utility Operators and Principals are Persons Conducting a Business or Undertaking (PCBU) under the Health and Safety at Work Act 2015. The National Code of Practice for Utility Operators Access to Transport Networks applies to all Utility Operators. The Wellington City Council Code of Practice for Working on the Road applies to all other parties working in the road corridor. All parties carrying out work in the roading corridor should be fully conversant with the requirements of the Health and Safety at Work Act 2015 and the code under which they are carrying out their work.

**Signed**



**Date** 07/09/2023

Jemal Dixon acting pursuant to delegated authority.

---

**FOR Corridor Manager APPROVAL USE ONLY**

Time Spent Processing:

Approved Contractor

Route Plan Submitted

TMP Submitted

Stockpiling Arrangements

# CONDITIONS

## Special Conditions

### 1. GENERIC - PARENT to CHILD

1. THIS TMP IS ONLY APPROVED FOR MINOR EXCAVATION WORKS.  
**(All major/project works require site specific TMP)**
2. All minor works are deemed as 20m or less of excavation. (National Code)
3. This Generic Parent CAR excludes any work on main roads with more than 2 minute delays. Confirmed through actual traffic counts taken onsite.
4. This Generic TMP is only approved with the specified conditions below. All documentation required for this to be used on site and shall be kept where it is always available for the Council`s TMC to review or access. Failure to supply this information, will result in the cancellation of this Parent CAR.
5. The use of a Generic CAR/TMPs does not automatically guarantee access to your worksite, check the online Road works report to make sure of any potential clashes: <https://wellington.govt.nz/services/parking-and-roads/road-works/road-works-and-road-closures>. With any onsite clashes agreement is to be reached and then uploaded onto the CHILD CAR.

### **PARENT/CHILD**

All conditions for this "CHILD CAR" are set out in the PARENT CAR Approval. The scope of work required at this site must comply with the conditions set in the PARENT CAR (PC).

This Parent CAR and the Full Scope of Works (FSOW) defines what work can be carried out under the child CAR's.

Child CARs must be requested at each excavation site

Each Child CAR must state the following in the work description

Child CAR to Parent XXXXXX  
(where XXXXXX is the number of this parent CAR)

### **Every child CAR must identify**

Worksite location that includes

A site plan with annotated (onsite street view) google image should be submitted with each CHILD CAR. This will clearly show the environmental/other constraints.

Actual dates of work including final reinstatement dates if different to work dates

Utility contact name

Site contractor 24/7 name and contact details

WCC Application of agreement to be uploaded to each CHILD CAR.

### **Documents on site:**

Hazard ID

Generic TMP Checklist

Onsite Record

### **Child CAR Documentation prior to works completion**

On site documentation

Before and after photos of initial works

Before and after photos of final reinstatement

Compaction Tests where applicable

**CAR Number:** R957162

5. If the approved TMD on the CHILD CAR is not fit for purpose, this should be documented on the onsite record and TMC should be notified. If no generic approved TMD is applicable to the site, work to be stopped and a site specific TMP should be submitted for approval.

6. All excavation work to be raised as a CHILD CAR, minimum of 5 days processing time. This is dependent on the affected parties. Example: bus routes, working close to schools, affecting metered parking. This is to be documented on your on-site record.

7. Any excavation work within the business area`s will be permanently re-instated within the timeframe set in the national code, unless otherwise agreed by TMC. If agreement is reached, this documentation will be uploaded in the CHILD CAR. Access for all users is to be maintained though-out the work-sites active and non-active times.

8. Business consultation in business/retail area`s should be discussed at least 3 weeks prior to physical start date, confirmation will be required to be uploaded to the CAR.

9. Noise Exemption Certificate is applicable for any works after the following working hours - 7h30 to 18h00.

10. Timeframe allocated for a CHILD CAR is no more than 2 weeks. Specific amount of actual working days should be documented on the CHILD CAR.

11. CAR Status is to be maintained and updated, to move your CAR in to warranty, work completion notification must be done, please upload before and after pictures to the CAR. Failure to supply will result in auditing and costs will occur.

12. This approval is conditional on the network user ensuring they meet the code of practice for temporary traffic management and health and safety and work act.

2.

### **GENERIC - GENERAL**

Prior to the expiry of this TMP, further work will be required to ensure that the actual TMDs used truly reflect the onsite conditions. It is expected that the approved TMDs will lessen over time based on your on-site checking assessments.

3. **CENTRAL BUSINESS DISTRICT**

**Reminder:** To minimise traffic disruption in the central business district no equipment movements are to happen within the hours of 7 to 9am and 4 to 6pm Monday to Friday. If site equipment is required into the closure then the movements are to happen outside this time.

4.

### **GENERIC - APPROVED**

Your approved generics have been accepted and approved, but these will require further enhancements, this is due to NZTA moving to a more risk-based approach for traffic management.

You are now required to show how this is mitigated in your generics and your onsite paperwork. It is expected that you will have developed a risk control plan (risk matrix) for your staff. All documentation on how this is achieved must be incorporated into your TMP. To help you develop your generics please see the new NZ guide to temporary traffic management document.

Your project may affect other key Wellington parties, such as GWRC bus companies (bus stop relocation, traffic management installation on bus routes) WCC Traffic Signals (temporary traffic management installation at or near permanent traffic signals) NZTA (when detour or additional traffic is on their network) Noise control (night works)

In such cases, please notify and document those that are affected. Also please ensure that

your TMP has the process that your STMS will follow to complete a safe site.

**GENERIC - ALL NON AND EXCAVATION WORKS.** (All excavations works are to be completed using the minor excavation CAR. Any works greater than 20 metres require site specific CAR and TMP).

This Generic TMP is only approved with the specified conditions below.

1. This Generic TMP is only approved with the specified conditions below. All documentation required for this to be used on site shall be kept where it is always available for the Council`s TMC to review or access. Failure to supply this information, will result in the cancellation of this Parent CAR.

2. Prior to any on-site works it is mandatory that the network user will upload their works programme by 12pm Thursday each week to council inbox, customercompliance@wcc.govt.nz. This will be uploaded to council's external webpage.

3. The use of a Generic CAR/TMPs does not automatically guarantee access to your worksite, check the online Road works report to make sure of any potential clashes: <https://wellington.govt.nz/services/parking-and-roads/road-works/road-works-and-road-closures>. With any onsite clashes agreement is to be reached and then uploaded onto the CHILD CAR.

4. This approval is conditional on the network user ensuring they meet the health and safety at work act.

**Note: If any legislative or RCA changes are required to this TMP then notification will be communicated through the CAR system.**

**The above could result in the current TMP not being suitable and could require redesigning. Please discuss directly with councils' officers.**

5. **WAP & TMP EXTENSIONS**

Applicant/Principal to advice WCC (customercompliance@wcc.govt.nz) if a WAP extension is needed. An updated TMP to be uploaded to the CAR for review. If stages of the work have been completed, the relevant TTM setups are to be deleted out of the TMP and TMP updated for only the necessary TTM set ups. WAP extensions will only be granted if work is rescheduled within a one-month period. If an extension is needed out of the one-month grace period, a new CAR is to be created and a TMP to be uploaded.

6. Generic TMP to be reviewed through the length of approval , With Risk and TTM set up being used to be monitored and to form the basis of the renewal at the end of the timeframe

**General Conditions**

7. The Utility Operator must:

(a) carry out all Work in Transport Corridors in accordance with the Code and KiwiRail's Specifications for Working in Railway Corridors;

(b) undertake all Works in compliance with the Acts of Parliament and mandated codes of practice that relate to their industry and the type of Work described within the plans and methodology submitted;

(c) install assets more or less in the location shown on the attached plans, and agree the exact location and position with the Road Corridor Manager before Work commences;

(d) locate any Utility Structures in the Road Corridor in the agreed position shown on the drawings and clear of the Carriageway, Road Corridor furniture and kerbs, drains, manholes,

etc. Utility Structures agreed to be within the trafficable part of the Road are to be flush with the surface and designed to withstand full heavy Traffic loading (NZTA's HN-HO-72 Traffic Loading);

(e) provide a full description of the construction methodology, reinstatement, resurfacing and compaction and agree this with the Road Corridor Manager prior to Work commencing;

(f) make the Works available at all times for inspection by any person representing the Road Corridor Manager;

(g) if requested, pay the reasonable costs of the Road Corridor Manager in connection with the processing of this notice and for the monitoring and auditing of the Works; (See NZ Transport Agency Cost Structure under Clause 23)

(h) keep a full copy of the Works Access Permit/ Permit to Enter and Reasonable Conditions on the Work Site at all times during the Works;

(i) undertake remedial action on non-conforming Work within the timeframe set by the Road Corridor Manager, where reasonable and practicable;

(j) gain all the necessary consents, approvals and permits from the relevant statutory and regulatory authorities at its own cost;

(k) keep plans of the installed Work and make them available to the Railway Corridor Manager (in all cases) and Road Corridor Manager (on request);

(l) compensate the Road Corridor Manager for any damage or costs incurred to the Road Corridor due to the Work or for costs resulting from the removal of abandoned installations, Utility Structures, components and equipment that belong to the Utility Operator;

(m) repair all Road Corridor assets damaged as a result of the Works, should the Road Corridor Manager determine these are necessary prior to the end of the Warranty period;

(n) restore to their original condition any surface or Utility Structure that was damaged or removed as a result of the Works;

(o) control the surface water channels so as to cause minimal interference to existing flows;

(p) fully restore the surface water channels at the completion of the Works;

(q) notify the Road Corridor Manager of any maintenance Work it proposes to undertake within the two-year Warranty period;

(r) have in place an approved TMP for Roads and Motorways at least two days prior to Work commencing on the Work Site;

(s) provide the Road Corridor Manager with two Working Days' notice before commencement of Work on the Work Site;

(t) ensure that the Work is carried out under the control of a warranted supervisor as required by the Code of Practice for Temporary Traffic Management and ensure that there are sufficient people on site specifically to control the flow of Traffic through the site in accordance with the TMP;

(u) comply with instructions from an officer of the NZ Police Traffic Safety Branch or a duly authorised agent of the Road Corridor Manager in respect of Traffic management and safety;

(v) complete Works in the Road Corridor in one continuous operation (suspension of Works over five continuous days requires the prior written permission of the Road Corridor Manager);

(w) protect and maintain all Road Corridor signs, markers, signals, barriers and associated marking and replace them to the appropriate industry standard where they have been damaged by the Works;

(x) complete and submit a Works Completion Notice form when the Works are complete; and

(y) stop Work as necessary to meet the requirements of section 42 of the Heritage New Zealand Pouhere Taonga Act 2014.

### **Local Conditions**

**CAR WCC Full Scope of Works Utility  
Utility**

Company	Wellington Water
Contract Manager	Tim Harty
Phone	021 451 104
Email	<a href="mailto:Tim.harty@wellingtonwater.co.nz">Tim.harty@wellingtonwater.co.nz</a>

**Contractor**

Company	Wellington Water alliance
Contract Manager	Valitha Roos
Phone	021 510 923
Email	Valitha.roos@wellingtonwater.co.nz

**Sub Contractor**

Company	
Name	
Phone	
Email	

Type of Work (Tick)	Project		Emergency		<b>Minor</b>	X
Location Road (Tick)	Carriageway	X	Footpath	X	Berm	X

**Work Location**

Physical Address	Various Locations / Streets within Wellington Southern Region
------------------	---

**Work Programme**

Start Date	01/08/2023	Completion Date	30/07/2024
Duration of Work	24/7	Day / Night	365

**Hours of work**

Start Time		Finish Time	
------------	--	-------------	--

**Description of Activity**

**P3/P4 Minor excavation works not needing site specific:**

**Note: all work not covered under the Generic Tmp / Tmd will need site specific.**

**Confirmation is required from RCA to see if Generic covers main arterial roads or suburban shopping areas.**

**Only approved contractors listed on Tmp are covered under Generic Car.**

**ALL CONTRACTORS ARE TO NOTIFY THE RCA PRIOR TO CARRY OUT THEIR WORK ACTIVITY.**

- All work carried out may involve having 1 to 2man onsite including sub-contractors.
- All digging works can involve but not limited to hand digging or using a digger when required.
- Any works that are not reinstated will follow the reinstatement requirements.

**Repairs:**

1. Leaks – 3 Water network leaks which covers repairs / replacement of council assets.
2. Repair / replacement of Tobies / meters / hydrants and valves that can be repaired on the same day.
3. Repair Manhole frame and centres.
4. Repair Stormwater and Wastewater laterals.



**Crews and Sub contractors must adhere to the following:**

- Ensure proper traffic and pedestrian management is in place.
- Set up correct Tmd to suit the work site.
- Complete a separate RCP form for every excavation.
- Safety induction is carried out as per RCP process.
- Ensure safety is always adhered to.
- Ensure all efforts are made to minimise disruption to residents, business, and pedestrians.
- Make sure relevant documents are onsite (utility plans).
- Mark out utility / council assets to carry out work above.
- Provide photos showing a wide street view of location.
- Photo of repairs.
- Photo after the repair and how the site was left.
- Clear notes of what was repaired.
- Where possible reinstatement will be completed after excavation.
- Site is packed up and left clean and tidy.

**Work Vehicles onsite at various stages of work but not limited to:**

**Standard work crew:**

1 to 2 service vehicles equipped with beacons onsite along with any small plant and equipment to carry out maintenance work. Crews to set up own Tmd.

**Service crews are equipped to set up the following Tmd's only.**

**Traffic management will be required if you do not carry correct signage.**

CC1	F2.1
CC2	F2.2
CC3	F2.5
CC4	F2.6
CC5	F2.7
CC7	J2.16A
CC8	
CC9	
CC10	
CC11	
CC12	

**Sub-contractors are to follow the Tmd criteria above, or if you do not have correct signage to set up own Tmd. Any Tmd not listed above will require external traffic management.**

**Extended crew when needed:**

- Hydro Vac Truck / Digger / Jet Flusher / Mini combo maybe utilised to assist with repairing leaks.
- Traffic management vehicles if unable to set up own traffic.
- Reinstatement vehicles / plant where possible.

**Reinstatement:**

**Note: all work not covered under the Generic Tmp / Tmd will need site specific.**

**Confirmation is required from RCA to see if Generic covers main arterial roads or suburban shopping areas.**

- Reinstatement must be completed as per National code requirements.
- Compaction test must be supplied as per National code requirements.
- If work is postponed or cancelled; works will go ahead the next safe and practical date possible weather permitting.
- Uneven surface and speed restriction signage will need to be installed and the site will need to be monitored once within each 24-hour period and recorded on the site record and monitoring form.
- Sites left unattended must be fenced off as per National code requirements.
- If for any reason a site has not been temp sealed, we must advise the Corridor Manager ASAP.
- **Temporary surface will need to be installed within one working day and full reinstatement to be completed as soon as possible weather permitting.**

**Work Vehicles onsite at various stages of work but not limited to:**

- 1 to 2 service vehicles equipped with beacons onsite along with any small plant and equipment to complete the work.
- Concrete truck / Hot Box Truck along with any small plant and equipment to complete the work.
- Digger / Roller.
- Traffic management vehicles if unable to set up own traffic.

**WHEN ARE SITE SPECIFIC TMP'S NEEDED:**

**Site Specific TMP required depending on the work activities and impact.**

**Works include sewer blocks / maintenance repairs on the wastewater network that require entry from a manhole at an intersection and/or in the live lane or excavations in the carriageway / live lane, burst water main/water leaks on the network in the carriageway / intersections that will impact traffic, hydrant / valve replacements in the carriageway that will impact traffic, water / wastewater lateral replacements that involve trenching across the carriageway.**

**This also includes works on the Stormwater network that may have an impact on traffic and project work taking more than 1 day.**

**ANY STATE HIGHWAY WORKS WILL BE AT THE DISCRETION OF CAPITAL JOURNEYS TMC  
ALL WORKS APPROVED BY CAPITAL JOURNEYS TMC MUST THEN BE NOTIFIED TO THE TRAFFIC OPERATIONS CENTRE (TOC) PRIOR TO COMMENCEMENT AND POST WORK WORKS ARE TO BE PLACED ON THE WEEKLY ROAD WORKS REPORT  
ALL COMPLETED WORKS MUST COMPLY TO WAP CONDITIONS AND ARE TO BE REINSTATED ACCORDING TO NZTA STANDARDS**

**Quantities of proposed Work (use meters, items, hours and minutes to indicate);**

Length of trenching		Number of Cabinets/pedestals effected	
Length of Horizontal/Vertical Drilling		Number of Structures effected (fully explain in description of work)	
Number of holes		Number of assets removed	
Number of Chamber/s effected		Duration of Road / Lane Closure (circle) Hours / Days	
Number of Poles/Posts/Piles effected		Duration of Footpath diversion (circle) Hours / Days	
Number of Car parks/bus stop/taxi stands affected for more than two hours		Duration of property access restricted (circle) Hours / Days	

# Health and Safety Policy



## Our Purpose |

Creating excellence in regional water services for healthy communities

## Our Vision

Our people, suppliers and affected parties go home healthy and safe

## Our Beliefs

- Health and safety is our top priority
- We look after ourselves; everyone takes personal responsibility for their own health and safety
- We look out for each other, suppliers and the public; we make sure everyone is safe
- Wellington Water takes a methodical approach to health and safety; we continuously review our systems to ensure they are up-to-date and ensure that health and safety is foremost in infrastructure planning and design
- We're committed to health and safety at all times; nobody walks past an unsafe activity or work site - we make it safe

## Our Commitments

### Leadership

- We make sure our people work in a safe environment
- We make sure our work sites are safe for suppliers, neighbours and the general public
- We empower our people to manage health and safety in all situations and to stop unsafe acts as they happen; we make sure there's a safe working environment before work continues
- We proactively identify and manage hazards and ensure safe behaviour
- We support the safe and early return to work of any of our people who are injured or sick, and support and follow up on anyone who is injured on a Wellington Water site
- We recognise staff and suppliers who practice excellence in health and safety

### Systems

- We make sure our people have the training, skills and resources to work safely
- We ensure infrastructure managed by Wellington Water is designed, constructed, operated and maintained safely, and will remain safe for our people, suppliers and the community
- We accurately record, investigate and report incidents and learn from them
- We monitor our health and safety performance and that of our suppliers as a basis for continuous improvement and identifying new and safer ways of working

### Working with others

- Our suppliers are required to commit to our vision of our people and suppliers going home healthy and safe
- We make sure all suppliers working on behalf of Wellington Water have high quality health and safety systems in place
- We comply with and exceed all relevant legislation, regulations, codes of practice and industry standards
- We interpret health and safety broadly and work with all stakeholders to achieve our health and safety vision

A handwritten signature in black ink, appearing to read 'Colin Crompton'.

COLIN CRAMPTON  
CHIEF EXECUTIVE



# Living Safely Policy

## People at the heart of everything we do

Living safely is how we go about every aspect of our lives; all day, every day. It is more than work, it is about integrating our work, home and interests, our desire to get the best out of life, and to be the best we can. It is recognising our strengths and weaknesses, and making positive choices that benefit our wellbeing and way of life, including those of others in the communities in which we live and work.

### We will:

- Demonstrate our commitment through active and visible leadership
- Abide by a simple safety management system that encourages health and safety ownership by each and every individual
- Incorporate health and safety into the way we design, plan and do our work
- Work collaboratively with our subcontractors to meet the required health and safety standards
- Enhance our health and safety skills and behaviours through training and development
- Foster a culture of reporting, learning and sharing
- Be empowered to maintain a safe and healthy workplace
- Promote a positive health and wellbeing mindset
- Meet or exceed relevant standards and legal requirements
- Set measurable objectives and targets to ensure continual improvement



C W Bruyn  
Managing Director

Subcontractor  Date

Project/Contract  Time

WWA Site Manager/ Supervisor  Auditor

Subcontractor Personnel contacted on Site:

**ALL "NO" RESPONSES ARE REQUIRED TO HAVE ACTIONS ENTERED INTO CAMS.**

PRE-SITE CHECKS	Comments / Observations / Verifications	
Signed, current subcontract agreement. (View record in CAS Register)	Record scope of works in agreement :	
Check CAMs cases for subcontractor over last 12 months. Record any significant issues/ items to follow up on and review on site.		
ON-SITE DOCUMENTATION/ OPERATIONAL REQUIREMENTS Relevant to subcontractors AND any sublet subcontractors.		
	Comments / Observations / Verifications	Achieved Yes/No/NA
What work is the subcontractor doing on site ? Verify work being completed by the subcontractor is covered by the scope of the subcontract agreement. NB: If NOT in scope a written /signed amendment to agreement is required.		
Number of subcontractor workers on site.		
Are any sublet workers (subbies subbie) on site? Record Company name, number on site and if approval for their use is documented.		
Are all subcontractor (and sublet) workers inducted onto site. (check Prestart Tailgate record / Induction register)		
Prestart / Risk Control Plan has been completed and all subcontractor (and sublet) workers have signed on. If using their own Risk Assessment forms are hazards risk rated, controls well defined and effective?		
Approved TMP or vehicle and pedestrian management plan is on site, fully implemented and effective.		
There is an emergency plan on site which includes emergency contact numbers and first aiders on site.		
Applicable H&S permits/notifications been completed correctly, available on site and used by subcontractors e.g. Worksafe notifications, Permit to Dig, Confined Space etc.		
Subcontractor has been provided with job specific details including job instructions, plans, specs and drawings etc. Check have current version numbers.		
Required tests, inspections and quality checks are being completed and documented by subcontractor including conformance of products and materials being used in the Subcontract works.		
All subcontractor incidents/non-compliances are being recorded and reported through CAMS.		
All relevant environmental resource consents/permits on site and conditions complied with by subcontractor- consider discharge to land, water or air.		

PPE/PPC worn on site by subcontractor workers is compliant with FH and client/activity requirements.		
Subcontractor workers have the correct licences/certifications for the plant they are operating. Seat belts worn where applicable.		
Subcontractor workers have relevant operational competencies for tasks they are doing e.g. Construct Safe card / TC or STMS / electrical registration		
Safety critical items of Subcontractors plant and equipment on site has been checked for compliance with FH / Regulatory requirements? e.g. Rego/ COF, flashing lights, reversing beepers, seatbelts, protective structures, anti-burst valves, emergency equip, plant in good condition, no visible wear on hydraulic hoses etc.	List Safety Critical Items of Plant and Equipment	
Subcontractors Vehicle/Plant daily pre-start checks completed and documented for all plant on site.		
Critical safety and quality equipment is calibrated or tagged e.g lasers, lifting gear, harnesses, gas meters		
Plant & Equipment is correctly isolated and Lock Out Tag Out procedures followed where required.		
Safe work methodologies implemented and observed adherence to Life Saving Rules e.g. working at heights, excavations, lifting, safety zones etc		
Hazardous substances are labelled, stored correctly and safe handling methods implemented		
General site condition – housekeeping standard, lighting,safe access/ egress		

**General Comments/Observations:**

--	--

**ACTIONS TO ENTER IN CAMS: CAMs No: \_\_\_\_\_**

Original to be placed on Contract file and a copy forwarded to SQE Department/Subcontractor Administrator:

Audit entered into CAMs  Copy forwarded to Subcontractor  Copy placed on Subcontractor File

# ROAD SPACE BOOKING

<b>Address:</b>			
<b>Contractor:</b>			
<b>Dates &amp; Times (attended):</b>	<b>From:</b>		<b>To:</b>
<b>Dates &amp; Times (unattended):</b>	<b>From:</b>		<b>To:</b>
<b>Generic TMP used:</b>			
<b>Diagram (s) used:</b>			
<b>CAR #</b>			
<b>Work Activity and Reasons TTM to remain in place:</b>			
<b>Contractor Name:</b>			
<b>Contractors Signature:</b>			
<b>TMC Approval:</b>			

Please attach photos of site active site set up (these photos are to include both ends of the site (inclusive of any side roads), pedestrian/cycle management and the working area.



### TRAFFIC MANAGEMENT PLAN (TMP) – FULL FORM

Use this form for complex activities. Refer to the NZ Transport Agency's Traffic control devices manual, part 8 Code of practice for temporary traffic management (CoPTTM), section E, appendix A for a guide on how to complete each field.

Organisations /TMP reference	TMP reference: ATMS 2023-110 <b>Southern</b> Excavation GTMP	Contractor (Working space): As per attached list	Principal (Client): Wellington Water		
		Contractor (TTM): As per attached list	RCA: Wellington City Council		
Location details and road characteristics	Road names and Suburb		House no./RPs	Road level	Speed Limit
	Various roads/ streets within the WCC <b>Southern</b> Zone (excluding SH)		From and to		
Traffic details (main route)	AADT		Peak flows		
	Various		Start	End	
			AM	0700am	0900am
		PM	1600pm	1800pm	

Description of work activity



**APPROVED**

CAR R957162  
Jemal Dixon

Wellington City Council

Page 1

07 September 2023

## WCC STH Excavation GTMP

### **P3/P4 Minor excavation works not needing site specific:**

**Note: all work not covered under the Generic Tmp / Tmd will need site specific.**

**Confirmation is required from RCA to see if Generic covers main arterial roads or suburban shopping areas.**

**Only approved contractors listed on Tmp are covered under Generic Car.**

**ALL CONTRACTORS ARE TO NOTIFY THE RCA PRIOR TO CARRY OUT THEIR WORK ACTIVITY.**

1. All work carried out may involve having 1 to 2man onsite including sub-contractors.
2. All digging works can involve but not limited to hand digging or using a digger when required.
3. Any works that are not reinstated will follow the reinstatement requirements.

### **Repairs:**

- Leaks – 3 Water network leaks which covers repairs / replacement of council assets.
- Repair / replacement of Tobies / meters / hydrants and valves that can be repaired on the same day.
- Repair Manhole frame and centres.
- Repair Stormwater and Wastewater laterals.

### **Reinstatement:**

**Note: all work not covered under the Generic Tmp / Tmd will need site specific.**

**Confirmation is required from RCA to see if Generic covers main arterial roads or suburban shopping areas.**

- Reinstatement must be completed as per National code requirements.
- Compaction test must be supplied as per National code requirements.
- If work is postponed or cancelled; works will go ahead the next safe and practical date possible weather permitting.
- Uneven surface and speed restriction signage will need to be installed and the site will need to be monitored once within each 24-hour period and recorded on the site record and monitoring form.
- Sites left unattended must be fenced off as per National code requirements.
- If for any reason a site has not been temp sealed, we must advise the Corridor Manager ASAP.
- **Temporary surface will need to be installed within one working day and full reinstatement to be completed as soon as possible weather permitting.**

### **Crews and Sub contractors must adhere to the following:**

- Ensure proper traffic and pedestrian management is in place.
- Set up correct Tmd to suit the work site.
- Complete a separate RCP form for every excavation.
- Safety induction is carried out as per RCP process.
- Ensure safety is always adhered to.
- Ensure all efforts are made to minimise disruption to residents, business, and pedestrians.
- Make sure relevant documents are onsite (utility plans).
- Mark out utility / council assets to carry out work above.
- Provide photos showing a wide street view of location.
- Photo of repairs. & Photo after the repair and how the site was left.
- Clear notes of what was repaired.
- Where possible reinstatement will be completed after excavation.
- Site is packed up and left clean and tidy.

**APPROVED**  
CAR R957162  
Jemal Dixon  
Wellington City Council  
07 September 2023

**Service crews are equipped to set up the following TMD's only:**

External Traffic Management will be required if you do not have the correct TTM equipment to install the required TTM closure.

CC1	Shoulder and roadside activities – Vehicle parked in carriageway	F2.1	Footpath diverted onto berm behind working space
CC2	Traffic not crossing road centre – Vehicle parked on carriageway	F2.2	Footpath diverted onto berm between working space and carriageway
CC3	Shoulder and roadside activities – Vehicle parked on berm	F2.5	Shoulder and roadside activities - Work on berm and/or footpath
CC4	Footpath diverted onto shoulder or parking lane	F2.6	Shoulder and roadside activities – Working in parking lane
CC5	Footpath guidance past the working space	F2.7	Shoulder Closure
CC7	Valve in shoulder or on berm	J2.16A	Cul-De-Sac Closure
CC8	Valve towards left of lane		
CC9	Valve towards right of lane		
CC10	Valve in centre of carriageway		
CC11	Valve in centre of intersection		
CC12	Less than 75m CSD		

**Work Vehicles onsite at various stages of work but not limited to:**

- 1 to 2 service vehicles equipped with beacons onsite along with any small plant and equipment to complete the repair.
- Hydro Vac Truck / Digger / Jet Flusher / Mini Combo may also be utilised to assist with repairs.
- Concrete truck / Hot Box Truck & or Roller along with any small plant and equipment to complete the reinstatement.
- Traffic management vehicles if unable to set up own traffic.

**WHEN A SITE SPECIFIC IS NEEDED:**

Site Specific TMP required depending on the work activities and impact to traffic / pedestrians.  
Project work taking more than 1 day will require a site specific.

**ANY STATE HIGHWAY WORKS WILL BE AT THE DISCRETION OF CAPITAL JOURNEYS TMC**  
**AII WORKS APPROVED BY CAPITAL JOURNEYS TMC MUST THEN BE NOTIFIED TO THE TRAFFIC OPERATIONS CENTRE (TOC) PRIOR TO COMMENCEMENT AND POST WORK**  
**WORKS ARE TO BE PLACED ON THE WEEKLY ROAD WORKS REPORT**  
**ALL COMPLETED WORKS MUST COMPLY TO WAP CONDITIONS.**

**APPROVED**  
 CAR R957162  
 Jemal Dixon  
 Wellington City Council  
  
 07 September 2023

**Planned work programme**

Start date	01/08/2023	Time	See Below	End date	30/07/2024	Time	See Below
------------	------------	------	-----------	----------	------------	------	-----------



**APPROVED**  
 CAR R957162  
 Jemal Dixon  
 Wellington City Council  
  
 07 September 2023

Consider significant stages, for example:

- road closures
- detours
- no activity periods.

*STMS to complete a risk assessment form prior to installing the TTM closure to ensure there is minimal disruption to road users.*

*Residential Roads*

*Installation: 7:30am – 8:00am or whenever site is installed.*

*Site Active: 8:00am – 17:30pm*

*Site Removal: 17:30pm – 18:00pm*

*Main Road*

*Installation: 9:00am -9:30am or whenever site is installed*

*Site Active: 9:30am – 15:30pm*

*Site Removal: 15:30pm – 16:00pm*

*Installation: 19:00pm – 19:30pm or whenever site is installed*

*Site Active: 19:30pm – 5:00am*

*Site Removal: 5:00am – 5:30am*

*Noise control approval is required for nightworks (outside of the standard working hours of 7.30am – 6pm.*

*This TMP is to cover 1 day attended Excavations works.*

Photos of the active site set up and onsite documents may be requested by the TMC to upload to CAR (these photos are to include both ends of the site (inclusive of any side roads), pedestrian/cycle management and the working area).

*Based on the photos provided, if the incorrect TTM has been installed (and/or considered dangerous) and/or outside of the approved TMP requirements, a Notice of Non-conformance may be considered.*

- A risk assessment is to be applied prior to selecting/installing TMDs.
- Reinstatement is to be planned same day or as soon as practicably possible. Pedestrian management (remaining on the path/berm) and shoulder closures can remain in place with fencing.
- Any works requiring pedestrian diversion onto the road or larger than a Shoulder Closure must be backfilled to road level with aftercare left in place or temporary sealed.
- Refer to WCC local code for backfilling of trenches.

APPROVED

CAR R957162

Jemal Dixon

Mellito City Council

Page 5

07 September 2023

## 10. BACKFILLING

### 10.1 General

Materials and compaction used are to be such that no discernible settlement occurs.

No cement, lime, or backfill materials containing them, may be used in backfilling work unless specifically required by this code or unless necessary around poles for stability purposes.

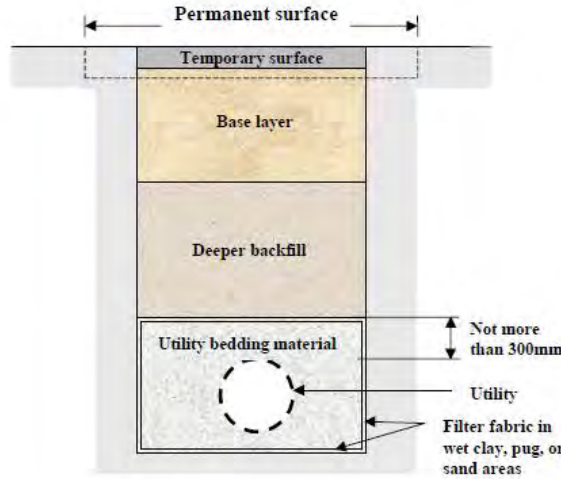

Figure 7 - Typical cross-section of a backfilled excavation

If Generic TMD(s) do not suit (based on the onsite risk assessment form) the site a Site Specific TMP will be required:

- Road Closure
- Or at TMCs request

Any changes to the approved TMP must be documented on the Onsite Record/Risk Assessment form (example below of how this will be recorded)

### Parking Restrictions

Parking restrictions are to be installed at least 24 hours in advance of the works occurring. Parking restriction signage is to show actual work times and dates. Parking restrictions are to use the appropriate signage.

Letter drop to be completed by the contractor at least 5 days prior to works commencing where required if work will take longer than 1 day to complete.

- A risk assessment form is to be completed prior to selecting/installing TMDs.
- Contractor to notify WCC when works are occurring as per the WCC weekly planned work programme.

Alternative dates if activity delayed

N/A – works will be carried out within the times/dates as listed. All programmed work will be submitted to WCC by 12pm Thursday each week for the weekly road works report.

Road aspects affected (delete either Yes or No to show which aspects are affected)

Pedestrians affected?	Potentially	Property access affected?	Potentially	Traffic lanes affected?	Potentially
Cyclists affected?	Potentially	Restricted parking affected?	Potentially	Delays or queuing likely?	Potentially

Proposed traffic management methods

**APPROVED**

CAR R957162

Jemal Dixon

Mullumbidgee City Council

07 September 2023

Installation  
(includes parking of  
plant and materials  
storage)

Once on site, the TMP will be implemented as follows:

- Parking legally and assessing the site and hazards using the on-site hazard form and using the risk matrix then picking a TMD to suit the emergency works with the lowest matrix score.
- 
- STMS to check the TMP is appropriate to the worksite. Where the TMP is not suitable, halt proceedings until the necessary actions have been taken
- All vehicles are to have correct signage and flashing beacons. They also need to have continuous and appropriate communication with the STMS and each other on an agreed channel at all times
- Work vehicles required on site will be parked within the site or parked legally nearby.
- Where these are affected STMS to contact Metlink (021 896 375 in first instance during business hours or 0800 801 700 afterhours) 30 minutes prior to site installation .
- Where these are affected STMS to contact WCCTOC (Orville Reyes 021 196 4733 or Tim Kirby 021 277 8243) 30 minutes prior to installation of works near or at traffic signals.
- Where these are affected STMS to contact WTOC (0800 869 286) 30 minutes prior to site installation of works near or at traffic signals on highways.

*Layout Procedure*

When it is not possible to walk the required signage out then the Installation of the site will be done under a level 1 mobile closure with appropriate work vehicles and crew.

- A site drive through will be conducted first to confirm layout, conditions and environment are all appropriate for works to proceed.
- Vehicle positioning will be as far to the left as practical and the installation vehicle will be stationary at the installation of each sign, with activity occurring only on the non-traffic side of the vehicle.
- Advanced warning signage will be installed first on the left, followed by progressive signage **installation in a 'loop' fashion around the site area.**
- Once ALL signage for the site has been installed delineation and direction signage will be installed in the following order;
  - Longitudinal Delineation (Along the lane)
  - Tapers & RD6 signage

Once all delineation is installed and prior to personnel, vehicle, plant and machinery populating the worksite, a drive through check must be performed by the STMS to ensure the site has been set up as per the selected TMDs, this should include the checking of worksite layout distances.

APPROVED

CAR R957162  
Jemal Dixon

Mellito City Council



07 September 2023

Attended (day)	<ul style="list-style-type: none"> <li>• An STMS or delegated TMO must be onsite at all times.</li> <li>• TC/STMS to assist pedestrians/cyclists/driveways and any resident/business driveways.</li> <li>• For MTC Stop/Stop &amp;, Stop/Go cyclists will be sent prior to any vehicles via a safe and sufficient route such as a footpath/berm based on risk assessment.</li> <li>• STMS to risk assess each site for any hazards and document them all on the risk assessment form.</li> <li>• Site checks are to be completed based on the risk assessment form and documented on the onsite record.</li> <li>• e-Stop portable traffic signals to be monitored and controlled at all times.</li> </ul> <p>Works near Signals:</p> <ul style="list-style-type: none"> <li>• Signage within 150m of traffic signals need WCCTOC approval.</li> <li>• Any affected signal loops must be first approved by WCCTOC and notified to WCCTOC during the pre-installation call to allow them to adjust signal management if required.</li> <li>• Signage within 150m of any traffic signals located on highways need approval from WTOC (0800 869 286). Any affected signal loops must be first approved by WTOC and notified to WTOC during the pre-installation call to allow them to adjust signal management if required.</li> </ul> <p>Works near Pedestrian Crossings:</p> <ul style="list-style-type: none"> <li>• Footpath Restricted / Diverted behind berm</li> <li>• Pedestrians may be directed to a temporary footpath in the carriageway.</li> <li>• Pedestrians may be escorted through the site.</li> <li>• Pedestrians may be directed to use the path on the other side of the road.</li> <li>• Pedestrians may be directed to use the path on the other side of the road, temporary refuge installed.</li> <li>• If a short-term closure of the footpath (&lt;5min) for site access is required, a spotter is to be used and any pedestrians are either asked to wait or walked around the plant when safe to do so.</li> <li>• Pedestrians will be directed to use an alternative crossing at the traffic lights on</li> </ul> <p>BUSES:</p> <ul style="list-style-type: none"> <li>• Metlink approval required for Bus Stop relocations/ Closures.</li> <li>• All signage to be placed in suitable position not obstructing Bus Stop.</li> <li>• Refer to the attached GWRC bus stop guidelines.</li> </ul> <p>CYCLIST:</p> <ul style="list-style-type: none"> <li>• A 30kph TSL will be established when cyclists are to be merged with traffic during these works.</li> <li>• A 30kph TSL and cyclist merging sign will be established when cyclists are to be merged with traffic during these works.</li> <li>• Cyclists to be held by MTC staff and guided to wait on the side of the road to be sent separately to traffic for safety.</li> <li>• The lane width will be over 4.0m and a TSL will not be required. We will establish a Cyclist merging sign before the work site.</li> </ul> <p>RUBBISH COLLECTION:</p> <ul style="list-style-type: none"> <li>• STMS to be mindful of rubbish collection days and assist when required.</li> </ul> <p>SCHOOLS:</p> <ul style="list-style-type: none"> <li>• All work must cease within 50m of the school 30minutes before and after the start and end of each school day</li> <li>• The working space is fenced and work will continue within the fenced area, no vehicles movements will take place 30minutes before and after the start and end of each school day</li> </ul> <p>The work area must take into account the increased number of pedestrians and cyclists and should be reduced to accommodate this 30minutes before and after the start and end of the school day</p>
----------------	--

**APPROVED**

CAR R957162  
Jemal Dixon

Mullumbidgee City Council



07 September 2023



Attended (night)	<p>Generic closures as per attached diagrams Site will be attended by a minimum of a level 1, AB STMS or higher. All staff on the site shall be briefed on the traffic management requirements before starting work on any site. If lighting towers are required, the STMS must ensure they do not cause a glare hazard for traffic. The STMS must consider the following on night shifts:</p> <ul style="list-style-type: none"> <li>• All night works are excluded from this TMP without the approval of noise and TMC.</li> <li>• An STMS or delegated TC/TMO must be onsite at all times.</li> <li>• TC/STMS to assist pedestrians/cyclists/driveways and any resident/business driveways.</li> <li>• For MTC Stop/Stop &amp; Stop/Go cyclists will be sent prior to any</li> <li>• vehicles via a safe and sufficient route such as a footpath/berm based on risk assessment.</li> <li>• STMS to risk assess each site for any hazards and document them all on the risk assessment form.</li> <li>• Site checks are to be completed based on the risk assessment form and documented on the onsite record.</li> <li>• e-Stop portable traffic signals to be monitored and controlled at all times.</li> <li>• Additional lighting is required.</li> </ul> <p>Works near Signals:</p> <ul style="list-style-type: none"> <li>• Signage within 150m of traffic signals need WCCTOC approval.</li> <li>• Any affected signal loops must be first approved by WCCTOC and notified to WCCTOC during the pre-installation call to allow them to adjust signal management if required.</li> <li>• Signage within 150m of any traffic signals located on highways need approval from WTOC (0800 869 286). Any affected signal loops must be first approved by WTOC and notified to WTOC during the pre-installation call to allow them to adjust signal management if required.</li> </ul> <p>Works near Pedestrian Crossings:</p> <ul style="list-style-type: none"> <li>• Footpath Restricted / Diverted behind berm</li> <li>• Pedestrians may be directed to a temporary footpath in the carriageway.</li> <li>• Pedestrians may be escorted through the site.</li> <li>• Pedestrians may be directed to use the path on the other side of the road.</li> <li>• Pedestrians may be directed to use the path on the other side of the road, temporary refuge installed.</li> <li>• If a short-term closure of the footpath (&lt;5min) for site access is required, a spotter is to be used and any pedestrians are either asked to wait or walked around the plant when safe to do so.</li> <li>• Pedestrians will be directed to use an alternative crossing at the traffic lights on</li> </ul> <p>BUSES:</p> <ul style="list-style-type: none"> <li>• Metlink approval required for Bus Stop relocations/ Closures.</li> <li>• All signage to be placed in suitable position not obstructing Bus Stop.</li> <li>• Refer to the attached GWRC bus stop guidelines.</li> </ul> <p>CYCLIST:</p> <ul style="list-style-type: none"> <li>• A 30kph TSL will be established when cyclists are to be merged with traffic during these works.</li> <li>• A 30kph TSL and cyclist merging sign will be established when cyclists are to be merged with traffic during these works.</li> <li>• Cyclists to be held by MTC staff and guided to wait on the side of the road to be sent separately to traffic for safety.</li> <li>• The lane width will be over 4.0m and a TSL will not be required. We will establish a Cyclist merging sign before the work site.</li> </ul>
------------------	---

APPROVED

CAR R957162

Jemal Dixon

Mellito City Council



07 September 2023

Unattended (day)	<p>Site should only be one day operation but in any case, that aftercare is needed:</p> <ul style="list-style-type: none"> <li>• STMS to risk assess potential unattended closure requirements and if a suitable/safe unattended closure/site can be installed prior to starting work. This is to be documented on the risk assessment form.</li> <li>• Where hazards are present an appropriate aftercare closure would be installed as required.</li> <li>• Contractor to perform risk assessment on site and determine if additional lighting sources are required.</li> <li>• A site check must be completed a minimum of once every 24hrs or as required due to adverse weather or complaints.</li> </ul> <p>As part of preparing the worksite to be left unattended, also consider the following actions:</p> <ul style="list-style-type: none"> <li>• Reduce the size of the worksite as much as possible</li> <li>• If TSLs have been installed, consider whether these are still required or whether the TSL should be changed (remember that changes to the TSL must be approved)</li> <li>• Sweep any loose material from the sealed road surface</li> <li>• Check that the road is trafficable for all types of traffic</li> <li>• Check that the footpaths are trafficable and that the cone bars have been removed and the appropriate fencing has been installed if required</li> <li>• Check that all signs are sand bagged and positioned correctly</li> <li>• Check that all delineation devices are clean and positioned correctly.</li> <li>• Consider the site visibility for hours of darkness or poor weather conditions.</li> </ul> <p>All equipment and materials must be positioned well clear of the live lanes and adequate protection for road users must be maintained at all times. Check that site lines for traffic is not blocked by plant or material</p> <p>Where possible, site is to be reduced to lessen impact to road users as and when possible</p> <ul style="list-style-type: none"> <li>• <i>Road Space Booking (attached), CAR and email notification to the TMC &amp; Corridor access manager will be required for any works required to be left unattended.</i></li> </ul>
------------------	--



**APPROVED**  
 CAR R957162  
 Jemal Dixon  
  
 07 September 2023

<p>Unattended (night)</p>	<p>Site should only be one day operation but in any case, that aftercare is needed:</p> <ul style="list-style-type: none"> <li>• STMS to risk assess potential unattended closure requirements and if a suitable/safe unattended closure/site can be installed prior to starting work. This is to be documented on the risk assessment form.</li> <li>• Where hazards are present an appropriate aftercare closure would be installed as required.</li> <li>• Contractor to perform risk assessment on site and determine if additional lighting sources are required.</li> <li>• A site check must be completed a minimum of once every 24hrs or as required due to adverse weather or complaints.</li> </ul> <p>As part of preparing the worksite to be left unattended, also consider the following actions:</p> <ul style="list-style-type: none"> <li>• Reduce the size of the worksite as much as possible</li> <li>• If TSLs have been installed, consider whether these are still required or whether the TSL should be changed (remember that changes to the TSL must be approved)</li> <li>• Sweep any loose material from the sealed road surface</li> <li>• Check that the road is trafficable for all types of traffic</li> <li>• Check that the footpaths are trafficable and that the cone bars have been removed and the appropriate fencing has been installed if required</li> <li>• Check that all signs are sand bagged and positioned correctly</li> <li>• Check that all delineation devices are clean and positioned correctly.</li> <li>• Consider the site visibility for hours of darkness or poor weather conditions.</li> </ul> <p>All equipment and materials must be positioned well clear of the live lanes and adequate protection for road users must be maintained at all times. Check that site lines for traffic is not blocked by plant or material</p> <p>Where possible, site is to be reduced to lessen impact to road users as and when possible</p> <ul style="list-style-type: none"> <li>• <i>Road Space Booking</i> (attached), CAR and email notification to the TMC &amp; Corridor access manager will be required for any works required to be left unattended.</li> </ul>
<p>Detour route</p>	<p>A detour route is not required or approved for this TMP</p> <p><b>Does detour route go into another RCA's roading network? No</b></p> <p><del>If Yes, has confirmation of acceptance been requested from that RCA? No</del></p> <p><del>Note: Confirmation of acceptance from affected RCA must be submitted prior to occupying the site.</del></p>

APPROVED

CAR R957162  
Jemal Dixon

Mellieburn City Council



07 September 2023

Removal	<ul style="list-style-type: none"> <li>Where these are affected the STMS is to contact Metlink (0800 801 700) for any works on a bus route or impacting bus stops 30 mins prior to installation – Refer to the attached GWRC bus stop guidelines.</li> <li>Where these are affected the STMS is to contact WCCTOC (Orville Reyes 021 196 4733 or Tim Kirby 021 277 8243) 10 mins prior to removing the closure.</li> <li>Where these are affected the STMS is to contact WTOC (0800 869 286) 10 minutes prior to site removal.</li> <li>If work is being completed at night, the above contacts are to be notified by 4pm of the expected finish time.</li> </ul> <p>Work plant / vehicles to be removed from site before closure is removed</p> <p>When it is not possible to walk the required signage in, Removal of the site will be done under a level 1 mobile closure with appropriate work vehicles and crew.</p> <ul style="list-style-type: none"> <li>Workspace delineation to be removed first (by either removing to the kerb for later collection or directly onto a stationary working vehicle)</li> <li>Centreline delineation may now be removed using the same method as installation</li> <li>Once all delineation is removed – <b>sign removal may commence in a clockwise 'loop' fashion (leaving advanced warning signage in place till last)</b></li> <li>A full site check being conducted prior to site departure.</li> </ul> <p>The STMS will carry out the final check before leaving the site.</p>
---------	--

Proposed TSLs (see TSL decision matrix for guidance)				
	TSL details as required Approval of Temporary Speed Limits (TSL) are in terms of Section 6 of Land Transport Rule: Setting of Speed Limits 2017, Rule 54001/2017 (List speed, length and location)	Times (From and to)	Dates (Start and finish)	Diagram ref. no.s (Layout drawings or traffic management diagrams)
Attended day/night	A temporary maximum speed limit of 10, 20, 30, 40, 50, 60km/h is hereby fixed for motor vehicles travelling over a maximum contiguous length of 800m on local roads within the Wellington City Council CBD Area as noted on the on-site record on a site-by-site basis.  STMS to document on the Onsite Record daily.	24hrs	01/08/2023 To 30/07/2024	F2.8, F2.9, F2.11, F2.12, F2.13, F2.14, F2.15, F2.16, F2.17, F2.18, F2.19, F2.20, F2.21, F2.22, F2.26, F2.27, F2.28, F2.29, ATMS02, ATMS03, ATMS04, J2.19a, J2.20a, J2.20b, J2.20c, J2.20d, J2.20e
Unattended day/night	A temporary maximum speed limit of 10, 20, 30, 40, 50, 60km/h is hereby fixed for motor vehicles travelling over a maximum contiguous length of 800m on local roads within the Wellington City Council CBD Area as noted on the on-site record on a site-by-site basis.  STMS to document on the Onsite Record daily.	24hrs	01/08/2023 To 30/07/2024	F2.8, F2.9, F2.11, F2.12, F2.13, , F2.18, F2.19, F2.20, F2.21, F2.22, F2.26, F2.27, F2.28, F2.29, J2.20a, J2.20b, J2.20c, J2.20d, J2.20e
TSL duration	Will the TSL be required for longer than 12 months? <i>If yes, attach the completed checklist from section I-18: Guidance on TMP Monitoring Processes for TSLs to this TMP.</i>			No

Positive traffic management measures

**APPROVED**  
 CAR R957162  
 Jemal Dixon  
 Member of the City Council  
  
 07 September 2023

The STMS onsite will ensure Positive Traffic Management Measures are in place to control vehicle speeds, increase public awareness and minimize disruption by providing clear and positive guidance.

This can include but not limited to:

- Side friction is used to create a tunnel effect for vehicles travelling past work sites to reduce the speed limit of the travelling vehicles, therefore providing a safer environment for the public and the contractors
- **Closer spacing's of delineation devices.**
- Using flashing beacons, flares, illuminated signs or temporary speed humps - must be discussed with respective RCA prior using onsite.
- If queuing or unforeseen disruption occurs, additional advanced signage may be used and further sign spacing (or more) outside
- Cone offset delineation - where cones are placed either side of a lane(s), the cones on one side are placed longitudinally offset from the other by a half cone spacing.
- STMS to install additional TM i.e. thresholds or pinch points to help reduce the speed of passing vehicles
- **STMS/TMO/TTM worker's to monitor and assist pedestrian activity around work areas so they safely pass works without interference with traffic**
- Police assistance may be sought if excess speed is a significant issue and presents a real and immediate danger to the activity or the public. Work may be suspended if driver behaviour at any time presents excess risk.
- Additional lighting to be installed at MTC positions (mandatory at night).

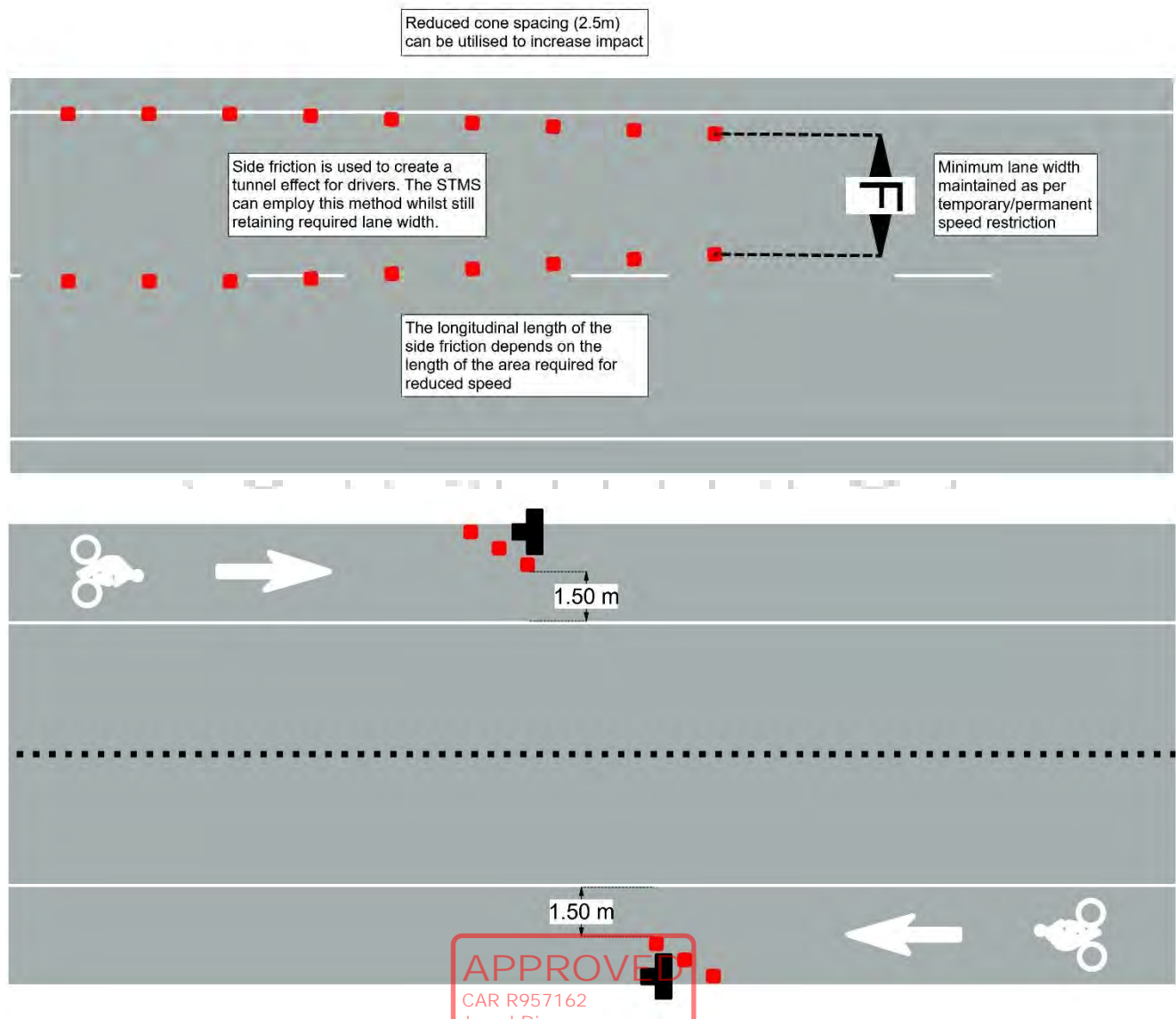



**APPROVED**

CAR R957162

Jemal Dixon

Member of City Council



07 September 2023

Contingency plans

<p>Generic contingencies for:</p> <ul style="list-style-type: none"> <li>major incidents</li> <li>incidents</li> <li>pre planned detours.</li> </ul> <p><i>Remove any options which do not apply to your job</i></p>	<p><b>Major Incident</b> A major incident is described as:</p> <ul style="list-style-type: none"> <li>Fatality or notifiable injury - real or potential</li> <li>Significant property damage, or</li> <li>Emergency services (police, fire, etc) require access or control of the site.</li> </ul>	<p><b>Actions</b> The STMS must immediately conduct the following:</p> <ul style="list-style-type: none"> <li>stop all activity and traffic movement</li> <li>secure the site to prevent (further) injury or damage</li> <li>contact the appropriate emergency authorities</li> <li>render first aid if competent and able to do so</li> <li>notify the RCA representative and / or the engineer</li> <li>under the guidance of the officer in charge of the site, reduce effects of TTM on the road or remove the activity if safe to do so</li> <li>re-establish TTM and traffic movements when advised by emergency authorities that it is safe to do so</li> <li>Comply with any obligation to notify WorkSafe.</li> </ul>
	<p><b>Incident</b> An incident is described as:</p> <ul style="list-style-type: none"> <li>excessive delays - real or potential</li> <li>minor or non-inquiry accident that has the potential to affect traffic flow</li> <li>structural failure of the road.</li> </ul>	<p><b>Actions</b> The STMS must immediately conduct the following:</p> <ul style="list-style-type: none"> <li>stop all activity and traffic movement if required</li> <li>secure the site to prevent the prospect of injury or further damage</li> <li>notify the RCA representative and / or the engineer</li> <li>STMS to implement a plan to safely remove TTM and to establish normal traffic flow if safe to do so</li> <li>re-establish TTM and traffic movements when it is safe to do so and when traffic volumes have reduced.</li> </ul>
	<p><b>Detour</b> If because of the on site activity it will not be possible to remove or reduce the effects of TTM once it is established a detour route must be designed. This is likely for:</p> <ul style="list-style-type: none"> <li>excessive delays when using an alternating flow design for TTM</li> <li>redirecting one direction of flow and / or</li> <li>total road closure and redirection of traffic until such time that traffic volumes reduce and tailbacks have been cleared.</li> </ul> <p>The risks in the type of work being undertaken, the risks inherent in the detour, the probable duration of closure and availability and suitability of detour routes need to be considered.</p> <p>The detour and route must be designed including:</p> <ul style="list-style-type: none"> <li>pre approval from the RCA's whose roads will be used or affected by the detour route</li> <li>ensure that TTM equipment for the detour signs etc are on site and pre installed.</li> </ul>	<p><b>Actions</b> When it is necessary to implement the pre-planned detour the STMS must immediately undertake the following:</p> <ul style="list-style-type: none"> <li>Notify the RCA and / or the engineer when the detour is to be established</li> <li>Drive through the detour in both directions to check that it is stable and safe</li> <li>Remove the detour as soon as it practicable and safe to do so and the traffic volumes have reduced and tailbacks have cleared</li> <li>Notify the RCA and / or the engineer when the detour has been disestablished and normal traffic flows have resumed.</li> </ul>

**APPROVED**  
 CAR R957162  
 Jemal Dixon  
 M. J. Dixon  
 07 September 2023

	<p>Note also the requirements for no interference at an accident scene:</p> <p>In the event of an accident involving serious harm the STMS must ensure that nothing, including TTM equipment, is removed or disturbed and any wreckage article or thing must not be disturbed or interfered with, except to:</p> <ul style="list-style-type: none"> <li>• save a life of, prevent harm to or relieve the suffering of any person, or</li> <li>• make the site safe or to minimise the risk of a further accident; or</li> <li>• maintain the access of the general public to an essential service or utility, or</li> <li>• prevent serious damage to or serious loss of property, or</li> <li>• follow the direction of a constable acting in his or her duties or act with the permission of an inspector.</li> </ul>
Other contingencies to be identified by the applicant (i.e. steel plates to quickly cover excavations)	<ul style="list-style-type: none"> <li>• If for any reason traffic delays exceed 5 minutes the STMS in charge of the site is to assess the traffic levels and the site will be either (in order of preference); modified, postponed or cancelled. Until traffic volumes reach an acceptable level</li> <li>• All reasonable steps will be taken immediately to open the site if emergency vehicles need to gain access or use the work site as thoroughfare</li> <li>• If adverse weather occurs while the site is still active, the STMS in charge of the site is to assess the weather conditions and the site will be either (in order of preference); modified, postponed or cancelled. Until weather conditions are acceptable for work to carry on</li> <li>• Site fencing will also be available if required</li> </ul>

Authorisations				
Parking restriction(s) alteration authority	Will controlled street parking be affected?	Yes (potentially)	Has approval been granted?	N/A
Pre-approval required from parking services before works commence.				
Authorisation to work at permanent traffic signal sites	Will portable traffic signals be used or permanent traffic signals be changed?	Yes (potentially)	Has approval been granted?	No
WCC TOC to be notified 30 mins prior to site installation and upon removal. Pre-approval required. WTOC to be notified 30 mins prior to site installation and upon removal of any works near highway traffic signals. Pre-approval required.				
Road closure authorisation(s)	Will full carriageway closure continue for more than 5 minutes (or other RCA stipulated time)?	No	Has approval been granted?	No
Road Closures not approved for this TMP				
Bus stop relocation(s) – closure(s)	Will bus stop(s) be obstructed by the activity?	Yes (potentially)	Has approval been granted?	No
STMS to contact metlink (0800 801 700) prior to installation and removal of site if buses and/ or bus stops are affected. Pre-approval required				
Authorisation to use portable traffic signals	Make, model and description/number	eSTOP Portable Traffic Signals: model# • 627 - 1, 627 - 2 • 628 - 1, 628 - 2 • 629 - 1, 629 - 2 • 630 - 1, 630 - 2 • <b>631</b> - 1, 631 - 2		
	NZTA compliant?	Yes		

EED			
Is an EED applicable?	Potentially	EED attached?	No – If an EED is required then TMC is to be contacted

Delay calculations/trial plan to determine potential extent of delays

**APPROVED**  
 CAR R957162  
 Jemal Dixon  
 M. J. [Signature]  
 07 September 2023



e-STOP & Stop Go Closures:

Risk assessment form to include if delays are likely to occur based on the assessment completed by the STMS prior to installing the TTM closure. Delay management to be documented on the risk assessment form where more than 500 VPD.

Delays of up to 2 minutes can be expected due to the nature of the TTM implemented. The STMS is to take measures to ensure delays remain under 2 minutes at all times, and queues do not extend past the advance warning signage.

If delays are occurring or excessive queueing is apparent, the STMS is to implement one of the following contingency plans:

1) Contact TMC.

2) Traffing Metering

Send only a specific amount of vehicles per side instead of clearing the entire queue

3) Pause works and open site

Make the site safe, remove plant and vehicles from the carriageway and open the tapers

4) Prioritise high flow route

Send vehicles from the approach with the highest flow first. Hold side street traffic for slightly longer if required.

5) Install additional signage

**Install T2A/T234 "Warning – Hidden Queue" signage up to 2xB from the initial advance warning signage for additional advance warning**

STMS will continuously monitor for delays – TMC will be notified of any excessive delays.

Public notification plan

For planned works a letter drop will be completed 5 days prior to works commencing.

Public notification plan attached? No

On-site monitoring plan

STMS onsite

The onsite **STMS Level 1/CAT A,B** or *delegated TMO* will be onsite at all times except for when they are conducting their 2 hourly site check. STMS may be away from the worksite to complete the site check as per CoPTTM Section C19.5.1 Monitoring frequency for TTM measures

**STMS handing over to TMO**

When the STMS is not able to be onsite they can hand the site over to a suitably qualified TMO (P) This must be a formal handover which will include a briefing of the site and documented.

Site management system:

- When the site is attended the STMS will monitor the site 2 hourly, maintain, and make any minor changes as necessary for the ongoing safety of the site
- All site checks and or minor changes to be recorded on the on-site records, or any other company or site documentation as required
- Major changes to be approved by TMC
- They will monitor the site efficiency, timings of traffic flow through the site and specifically the safety of cyclists and pedestrians passing through the controls
- Signs are visible and positioned as per approved plan
- Correct and clean equipment is used
- High visibility jackets are used by all staff and visitors and are done up and compliant.
- The first inspection should take place as soon as the equipment has been installed. This should verify that all devices are correctly in place, no item has been omitted, all equipment meets its cleanliness requirements and no conflicting messages exist between permanent signs. Temporary signs and other devices
- Site maintenance will be completed in the manner appropriate for the level of the road and speed limits
- Additional inspections during inclement weather and high winds will be done at STMS discretion

Attended  
(day and/or night)

Following any change to an attended site:

A full check of the site will be completed and documented

**APPROVED**  
CAR 8957162  
Jermal Dixon  
Muller + Co  
07 September 2023

Unattended (day and/or night)	Site should only be one day operation but in any case, that aftercare is needed: <ul style="list-style-type: none"> <li>• During day light hours of inactivity, the site will be monitored once in a 24hr period, including Saturday/Sunday and public holidays.</li> <li>• Additional inspections during inclement weather and high wind,</li> <li>• <i>Extra site checks may be required if complaints are received, or site checks are showing a consistent requirement for more than one site check</i></li> </ul>
----------------------------------	--

Method for recording daily site TTM activity (eg CoPTTM on-site record)

**The attached "On-Site Record" sheet is to be used to record the monitoring of the TTM to ensure the traffic management measures remain fit for purpose, suitable, installed and used correctly. Monitoring will follow the prompts provided on the recording sheet, and if multiple STMS' check this site, each STMS must initial and sign for the respective times.**

The worksite monitoring including:

- the site set-up and removal
- 2-hourly monitoring
- Hazard ID sheet
- Risk assessment form
- On-site record form
- Checking process for Generic TMPs form to be completed prior to set up of a worksite when using this TMP.

This will be retained with approved TMP for 12 months and is available on request at any time.

Site safety measures

PPE requirements are as per the clients minimum standard and this MAY include the following:

- *Hard Hat (when within 5m of moving machinery / at risk of falling objects)*
- *High ankle lace up steel cap boots*
- *Hi-Vis vest as per CoPTTM, (eg TTMC-W)*
- *Long pants, long sleeves*
- *Safety glasses*
- *Gloves (task specific, when there is risk of hand injuries)*
- *All other PPE will be as per standard work activity requirements*
- The STMS will wear a CoPTTM compliant STMS vest.

TTM Induction Briefing  
Before occupation of the working space, staff on-site will be given a TTM Induction Briefing at a safe location that is clear of the live lane (tool-box meeting) by the STMS on the conditions of the accepted traffic management plan. This will include but not limited to, entry to the worksite, material delivery, role responsibilities, PPE, hazards and controls, safety (no go) zones and first aid / emergency procedures.

Site Visitors  
All visitors are to report to (or be directed to) the STMS who will advise the safety procedures and hazards specific to the temporary traffic management deployed. Visitors are required to wear a compliant high visibility vest but may require additional PPE to enter the working space. All visitors must sign the TTM Induction Briefing as acknowledgment of understanding the safety and hazard requirements.

Working Space / PPE  
Compliant PPE (as specified by the site fore person) must be worn before entering the working space. All personnel entering the working space must be briefed by the site fore person on the hazards present and any emergency procedures (e.g., location of first aid kit, staff with first aid certification and nearest medical centre).

Night works

- Staff working at night will use personal lighting to improve visibility where required
- Overhead lighting will be required for all MTC staff
- Overhead lighting will be in place for work crew to highlight the work area hazards

**APPROVED**  
 CAR R957162  
 Jemal Dixon  
 Member of the City Council  
  
 07 September 2023

Temporary safety barrier system	Will a temporary safety barrier system be used at this worksite?	No	If yes, has the temporary safety barrier system been designed by an installation designer and independently reviewed as being fit for purpose?	N/A
	Statement from temporary safety barrier installation designer attached			N/A

Other information

**LEVEL 1 LAYOUT DISTANCES TABLE**

Permanent speed limit or RCA-designated operating speed (km/h)		≤50	60	70	80	90	100		
<b>Traffic signs</b>									
A	Sign visibility distance (m)	50	60	70	80	90	100		
B	Warning distance (m)	50 or 30*	80	105	120	135	150		
C	Sign spacing (m)	25 or 15*	40	50	60	70	75		
<b>Safety zones</b>									
D	Longitudinal (m)	10 or 5*	15	30	45	55	60		
E	Lateral (m)	1	1	1	1	1	1		
<b>Tapers</b>									
G	Taper length (m)*	30	50	70	80	90	100		
K	Distance between tapers (m)	40	50	70	80	90	100		
<b>Delineation devices</b>									
Cone spacing in taper (m)		2.5	2.5	5	5	5	5		
Cone spacing: Working space (m)		5	5	10	10	10	10		
<p>* Larger minimum distances apply on all state highways and also on all multi-lane roads. The smaller minimum distances may be applied on other roads to accommodate road environment constraints.</p> <p># On non-state highways with speeds 50km/h or less, a <b>10m taper</b> (with cones at 1m centres) may be used when there are road environment constraints (eg intersections and commercial accesses). On all roads where shoulder width is less than 2.5m and the activity does not affect the live lane, a <b>10m shoulder taper</b> is permitted (with at least 5 cones at no greater than 2.5m centres). A taper of <b>30m</b> (with cones at 2.5m centres) <b>must</b> be used where manual traffic control (stop/go), portable traffic signals or priority give way are employed.</p>									
<b>Lane widths</b>									
Speed (km/h)		30	40	50	60	70	80	90	100
F	Lane width (m)	2.75	2.75	3.0	3.0	3.25	3.25	3.5	3.5

Except for delineation device spacings, which are maximum values, the distances specified in the above tables are minimum values.

Diagrams

Number	Title
CC1	Work on berm or footpath - light vehicle parked in carriageway
CC2	Traffic not crossing centre- heavy vehicle parked in carriageway
CC3	Work on berm and/or footpath - work vehicle parked on berm

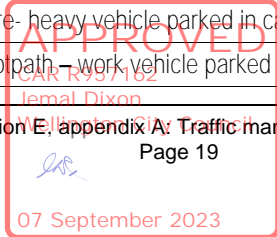
  
 Jemal Dixon  
 M. J. Dixon  
 07 September 2023

CC4	Footpath diverted onto Shoulder or parking lane
CC5	Footpath controller guiding pedestrians past the working space
CC7	Value in shoulder or on berm
CC8	Valve towards left of the lane
CC9	Valve towards right of the lane
CC10	Valve in centre of the carriageway
CC11	Valve in centre of the intersection
CC12	Less than 75m CSD
F2.1	Footpath – Footpath diverted onto berm behind working space
F2.2	Footpath – Footpath diverted onto berm between working space and carriageway
F2.3	Footpath – Footpath diverted onto carriageway
F2.4	Footpath – Footpath closed – permanent speed less than 65km/h
F2.5	Shoulder and Roadside Activities – Work in berm and/or footpath
F2.6	Shoulder and Roadside Activities – Work in parking lane
F2.7	Shoulder and Roadside Activities – Shoulder closure
F2.11	Two-Way Two-Lane Road – Traffic not crossing road centre
F2.12	Two-Way Two-Lane Road – Traffic not crossing road centre – Signs on median
F2.13	Two-Way Two-Lane Road – Traffic crossing road centre
F2.14	MTC alternating flow – Single lane
F2.15	MTC temporary stop
F2.16	Priority giveway
F2.17	Portable traffic lights
F2.18	Two-Way Two-Lane Road – Work in centre of the road
F2.19	Two-Way Two-Lane Road – Intersection or roundabout – Road works on side road after intersection – TSL on side road – Traffic not crossing road centre
F2.20	Two-Way Two-Lane Road – Intersection or roundabout – Road works on side road after intersection – TSL on main road – Traffic not crossing road centre
F2.21	Two-Way Two-Lane Road – Intersection or roundabout – work in middle of intersection
F2.22	INT – MTC at intersection
F2.26	Other Hazards – Flooding, washout, slips
F2.27	Unattended new seal
F2.28	Unattended surface hazard
F2.29	Unattended seal repairs
F2.30	One-Way Two-Lane Divided or Two-Lane Road – Left-lane closure
F2.31	One-Way Two-Lane Divided or Two-Lane Road – Right-lane closure
F4.1	Two-Way Two-Lane Road – Work vehicle is more than five (5) metres from the edgeline
F4.2	Two-Way Two-Lane Road – Work vehicle is within five (5) metres from the edgeline
F4.3	Two-Way Two-Lane Road – Work vehicle is within five (5) metres from the edgeline – Speed limit over 65km/h
F4.4	Two-Way Two-Lane Road – Work vehicle is in a lane
F2.8	Cycle Lane – Traffic not crossing road centre
F2.9	Cycle lane – Traffic crossing road centre – Diverted cycle lane – coned lane control
F4.10	Inspection Activities and Non-Invasive works
ATMS02	Single -lane alternating flow – Portable e-Stops

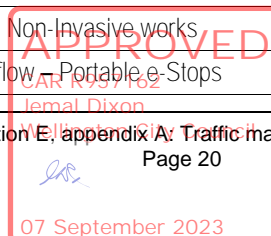

ATMS03	Cycle lane – Cycle lane closed – Portable e-STOP
ATMS04	Closure at intersection or roundabout – Portable e-Stops with MTC on side roads
ATMS05	Pedestrian Provision – Footpath closed – Pedestrian escorted
ATMS06	One-Way Two-Lane divided or Two-Lane Road – Part or all of a lane occupied – Semi-static closure – work for up to 1 hour
ATMS07	Inspection Activities and Non-Invasive works – Centre of road
ATMS08	Two-Way Two-Lane Road – Cul De Sac Closure
J2.16a	Two-Way Two-Lane Road – short no exit road
J2.19a	Two-Way Two-Lane Road – intersection or roundabout – Major obstruction close to intersection
J2.20a	Two-Way Two-Lane Road – Intersection or roundabout – After intersection – Traffic not crossing road centre
J2.20b	Two-Way Two-Lane Road – Intersection or roundabout – After intersection – Traffic crossing road centre
J2.20c	Two-Way Two-Lane Road – Intersection or roundabout – Before intersection – Traffic not crossing road centre
J2.20d	Two-Way Two-Lane Road – Intersection or roundabout – Before intersection – Traffic crossing road centre
J2.20e	Two-Way Two-Lane Road – Intersection or roundabout – On median near intersection
Mobile Closure	Install and removal

ALL TRAFFIC MANAGEMENT SERVICES  
atms

APPROVED

CAR R957162

Jemal Dixon

Mellisham City Council



07 September 2023

Contact details						
	Company / Council	Name	24/7 contact number	CoPTTM ID	Qualification	Expiry date
Principle	Wellington Water	Tim Harty	021 451 104	-	-	-
TMC	Wellington City Council	Amanda Wolfaardt	021 723 080	128480	L 2/3 NP	16/09/23
<b>Engineers' representative</b>	Wellington Water	Valitha Roos	021 510 923	-	-	-
Service Delivery Manager	Wellington Water	Alistair Forsyth	021 507 440	-	-	-
Contract interim contacts	Citycare	Wayne Kelland	027 263 8731	-	-	-
	Citycare	Mark Thompson	027 542 6244	-	-	-
	Citycare	Paul Coles	03 941 7225	-	-	-
	Dawson Waste Services Ltd	Jan Godfrey	04 528 9909	-	-	-
	Davies Waste Solutions	Evan Davies	027 283 8831	-	-	-
	RS Cabling	Nathan Rose	027 275 4317	-	-	-
	SAP Contractors	Glenn Churches	027 272 1666	-	-	-
	SAP Contractors	Jonathon Manava	027 216 6651	-	-	-
	Silver Lining Contracting Ltd	Renee Wilkie	021 0828 0647	-	-	-
	Greenstone	Whai Williams	04 566 0890	-	-	-
	Cubic Metre	Taupau Peni	021 345 379	-	-	-
	Cubic Metre	Andrew McWhirter	021 345 79	-	-	-
	Kahu Contractors	Harold Paul	021 027 37643	-	-	-
	Jet black Asphalt	Neville Playford	027 2089309	-	-	-
	GP Friel	Dave Phillipson	022 657 2402	-	-	-
	Detection Services	Tim Armstrong	027 4576 113	-	-	-
	Detection Services	Ross Beckett	04 915 0530	-	-	-
	E Carson & Sons	Eddie Carson	027 442 4343	-	-	-
	AD Riley & Co Ltd	Chris Parkinson	021 305 637	-	-	-
	P & N Siteworks	Peter Lindsey	027 2358 363	-	-	-
	Central Plumbing (Wellington) Ltd	Anthony Eden	022 6385 704	-	-	-
	WAL Gordon Plumbing	Wal Gordon	027 2114 007	-	-	-
	Cardino NZ Ltd	Jane Nichols	021 199 5917	-	-	-
	Intergroup	Wayne Carling	027 239 7187	-	-	-
	Intergroup	Kerrod Foaease	021 133 5973	-	-	-
	G P Friel Ltd	Dave Phillipson	022 657 2402	-	-	-
	SONAS	Edward Rooney	027 326 4068	-	-	-
	Southeys Group	Leonard Vertigans	027 275 4315	-	-	-
	S & R Asphalts Ltd	Scott Hay	027 440 2405	-	-	-
	Multi Civil Contractors Limited	Cody Pepere	027 322 6483	-	-	-
Hydrotech Group	Neil Cherry	021 730 502	-	-	-	
Hydrotech Group	Paul Reynolds	021 730 486	-	-	-	
Quik-Shot Trading as AES	Eddy Warda	022 018 0705	-	-	-	

	HCC Trade Waste Team	Pakau Tanirau	027 2441 6376	-	-	-
	HCC Trade Waste Team	David Fahey	027 642 3345	-	-	-
	Drain Doctors	Ian Pauley	04 566 9252	-	-	-
	Wellington Pipelines	James Fruean	027 499 9223	-	-	-
	PTS	Bux Manuseuga	027 836 5243	-	-	-
	Mottmac	Patrick Wharewera-Jones	027 746 8395	-	-	-
	Mottmac	Matthew Cooper	021 688 013	-	-	-
	Vac U Digga	Kathy Fandham	021 246 3615	-	-	-
	Ace Drain Unblockers	Rudolf Roppl	027 249 7492	-	-	-
	Concrete Cutting NZ	Aldon Solomon	021 737 674	-	-	-
	Contract Sealing	Chris Curtis	027 487 3726	-	-	-
	Concrete Solutions Ltd	Cameron Dearlove	021 744 317	-	-	-
	Construction Contracts Limited (CCL)	Steve Scrimshaw	(04) 567 9777	-	-	-
	E N Ramsbottom Ltd	Michelle Hoffman	027 471 6246	-	-	-
	Horokiwi Paving Limited	Peter Green	027 443 2206	-	-	-
	McCormack Group	Willy McCormack	027 449 3985	-	-	-
	PCL Contracting Ltd	Luke Lee	027 210 2079	-	-	-
	Podium Concrete	Bradley Roberts	(04) 237 9595	-	-	-
	Pope & Gray	Jeremy Gray	027 466 5538	-	-	-
	Precision Concrete Pumping & Spraying Limited	Steve Graham	027 233 1794	-	-	-
	Rob's Concrete Cutting	Robert Betty	021 631 957	-	-	-
	Shane McGrath Contracting	Shane McGrath	027 493 8911	-	-	-
	Solid Art Concrete	Nui Rinui	022 126 2130	-	-	-
	TQ Concrete Placers Ltd	Tom Paki	027 404 2032	-	-	-
	Groundworks Ltd	Brigid Smith	021 281 2357	-	-	-
	McLatchie & Sharp Ltd	Adam Clarke	027 443 3760	-	-	-
	Higgins Contractors	Peter Herbert Paul Baddington	(04) 472 8460	-	-	-
	Ives Plumbing Ltd	Terry Ives	027 443 0469	-	-	-
	Action Civil	Dave Murtagh	027 442 2971	-	-	-
TTM Interim Contacts	ATMS	Vena Lam Sam	021 767 165	39930	ABC - P	22/09/24
	ATMS	Martyn Sauaiga	027 348 9478	72781	AB - P	19/08/25
	PTS	Bux Manuseuga	027 836 5243	-	-	-
	Men@Work TM	Office	0800 636 289	-	-	-
	TMNZ	Steven Loftus	027 4919 494	-	-	-
	TMNZ	Office	04 237 7712	-	-	-
	Wellington Water	Steve Watt	021 507 440	-	-	-
	Citycare	Wayne Kelland	027 263 8731	-	-	-
	Citycare	Mark Thompson	027 542 6244	-	-	-
	SAP Contractors	Glenn Churches	027 272 1666	-	-	-
	SAP Contractors	Jonathon Manava	027 216 6651	-	-	-

APPROVED  
 CAR R95/162  
 Jemal Dixon  
 07 September 2023

	Silver Lining	Bill Wilkie	021 082 20647	-	-	-
	Greenstone	Whai Williams	04 566 0890	-	-	-
	Cubic Metre	Taupau Peni	021 345 379	-	-	-
	Jet black Asphalt	Neville Playford	027 2089309	-	-	-
	Cardino NZ Ltd	Jane Nichols	021 199 5917	-	-	-
	RS Cabling	Nathan Rose	027 275 4317	-	-	-
	HCC Trade Waste Team	Pakau Tanirau	027 2441 6376	-	-	-
	HCC Trade Waste Team	David Fahey	027 642 3345	-	-	-
	P & N Siteworks	Peter Lindsey	027 2358 363	-	-	-
	Central Plumbing (Wellington) Ltd	Anthony Eden	022 6385 704	-	-	-
	Detection Services	Tim Armstrong	027 4576 113	-	-	-
	Quik-Shot Trading as AES	Eddy Warda	022 018 0705	-	-	-
	Hydrotech Group	Neil Cherry	021 730 502	-	-	-
	Hydrotech Group	Paul Reynolds	021 730 486	-	-	-
	Intergroup	Wayne Carling	027 239 7187	-	-	-
	Intergroup	Kerrod Foese	021 133 5973	-	-	-
	Shepherd Traffic Management Solutions	Richard Shepherd	029 777 9099	-	-	-
	Men At Work	Kurt Puryer-Smith Todd Lynch Ratu Kapaiwai	027 274 2369 027 282 0998 027 514 9675	- - -	- - -	- - -
	TPlans Limited	Tayla Varcoe	021 717 592			
	Traffic Safe	Julie Hitchcock	027 450 6565			
	Traffic Management NZ Ltd	Ian Satherley	021 400 023			
Others as required	WCC TOC	Orville Reyes Tim Kirby	021 196 4733 021 227 8243	-	-	-
	Metlink Contact Centre		0800 801 700	-	-	-
	WTOC		0800 869 286			

TMP preparation							
Preparation	Name (STMS qualified)	Date	Signature	ID no.	Qualification	TTMP	Expiry date
		Pania Werahiko	26/07/2023	<i>P Werahiko</i>	149481	STMS (A) – NP STMS (B) – NP	

\* additional column added to indicate the attended (or confirmed booking) date of the named designer on the NZTA Temporary Traffic Management Planners (TTMP) workshop as required by the NZTA technical note, issued 9 December 2019

This TMP meets CoPTTM requirements					Number of diagrams attached		58
TMP returned for correction (if required)	Name	Date	Signature	ID no.	Qualification	Expiry date	
	Engineer/TMC to complete following section when approval or acceptance required						
Temporary safety barrier system	The attached temporary road safety barrier design has been independently reviewed as being fit for purpose					Not required	



TMP Approved						
	Name	Date	Signature	ID no.	Qualification	Expiry date
Acceptance by TMC (only required if TMP approved by engineer)						
	Name	Date	Signature	ID no.	Qualification	Expiry date

Qualifier for engineer or TMC approval

Approval of this TMP authorises the use of any regulatory signs included in the TMP or attached traffic management diagrams.

This TMP is approved on the following basis:

1. **To the best of the approving engineer's/TMC's judgment this TMP conforms to the requirements of CoPTTM.**
2. This plan is approved on the basis that the activity, the location and the road environment have been correctly represented by the applicant. Any inaccuracy in the portrayal of this information is the responsibility of the applicant.
3. The TMP provides so far as is reasonably practicable, a safe and fit for purpose TTM system.
4. **The STMS for the activity is reminded that it is the STMS's duty to postpone, cancel or modify operations due to the adverse traffic, weather or other conditions that affect the safety of this site.**

Notification to TMC prior to occupying worksite/Notification completed

Type of notification to TMC required	Wellington City Council weekly road works report	Notification completed	Date	Every Thursday
			Time	By 12pm



**APPROVED**  
 CAR R957162  
 Jemal Dixon  
  
 07 September 2023

# Risk Control Plan

**Date:** \_\_\_\_\_ **Client:** Company Name



<b>STMS:</b> Name & Number	<b>Client Forman Onsite:</b> Name & Number	<b>ATMS Vehicle/s:</b>
<b>Site:</b> Address	<b>Job Number:</b>	<b>First Aider(s):</b> Name
<b>Suburb:</b> Location	<b>RCA:</b> Local Council or NZTA	<b>First Aid Kit:</b> Location
<b>TMP Reference Number:</b>	<b>Diagram Being Used:</b>	<b>Nearest Hospital or Clinic:</b> Address / Location
<b>Closure Type:</b>	<b>TSL Installed:</b>	<b>Assembly Point:</b> Name & Number
<b>Is Generic Check List Needed?</b>	<b>Is Mobile Onsite Record Needed?</b>	<b>Fire Equipment:</b> Location
<b>Site Installation Time:</b> Time	<b>Site Fully Dismantled Time:</b> Time	<b>Spill Kit:</b> Location

**What is the plan for the day? Noted changes.**

---



---



---



---

**RISK MATRIX - Consider the likelihood of the event happening**

	Very unlikely to happen.	Unlikely to happen.	Possibly could happen.	Likely to happen.	Very likely to happen.	Hierarchy of controls
<b>Catastrophic/Extreme (e.g. Fatal, damage to plant, environment, organisation)</b>	Medium	High	Critical	Critical	Critical	You can lower the risk by using the most effective controls. Always start from the top (Eliminate), and if it is not practicable, then consider the next control in the hierarchy.
<b>Major (e.g. Permanent disability, damage to plant, environment, organisation)</b>	Low	Medium	High	Critical	Critical	<b>Eliminate:</b> 1. Eliminate the hazard
<b>Moderate (e.g. Hospitalisation/short- or long-term disability, damage to plant, environment, organisation).</b>	Low	Medium	High	Critical	Critical	<b>Minimise:</b> 2. Substitute the hazard 3. Isolate the hazard 4. Use engineering controls 5. Use administrative controls 6. Use PPE
<b>Minor (e.g. First aid, damage to plant, environment, organisation).</b>	Low	Low	Medium	High	Critical	
<b>Superficial/minimal (e.g. No treatment required, damage to plant, environment, organisation).</b>	Low	Low	Low	High	High	

**PPE Requirements for the task (tick all that apply)**

	<b>Compulsory</b> Day-glo vests, shirts or overalls are mandatory on all work sites (worn done up) <input checked="" type="checkbox"/>		P2 mask to worn when in the vicinity of machinery that can cause dust and fumes <input type="checkbox"/>
	<b>Compulsory</b> Steel or composite capped lace up boots are mandatory on all work sites <input checked="" type="checkbox"/>		Full cover clothing or overalls must be worn where there is a risk of abrasions, exposure to heat, CAL rated clothing to be worn in on electrical work sites <input type="checkbox"/>
	Must be worn on site when something could fall on you, or you could fall <input type="checkbox"/>		Must be worn when risk of dust or foreign objects entering the eye. Or when handling hazardous materials. <input type="checkbox"/>
	Must be worn when operating all machinery or when you need to raise your voice to be heard by someone 1 m away <input type="checkbox"/>		Must be worn when handling hazardous materials or when handling sharp objects (not to be worn when there is a risk of entanglement) <input type="checkbox"/>
	<b>Compulsory if working off the deck</b> Harness and lanyards must be used correctly when on the deck of work vehicles. <input type="checkbox"/>	<b>Other PPE Required:</b>	

**Important contact numbers: in an emergency call 111**

- Mana Harding – HR/H&S Manager – 027 213 5654
- Jade Ng – General Manager – 021 767 541
- Karl Beglin – Fleet/Operations – 021 529 729



**Is there a critical risk onsite?** YES / NO

- High/Critical chance of falling from height (no harness onsite)
- High/Critical chance of entrapment or lack of escape route
- High/Critical chance of there being a safety zone/live lane breach.

**If answer yes:**

Supervisor/Manager Called/Time \_\_\_\_\_

Outcome? Continue with controls or stop work \_\_\_\_\_



**Physical Distancing** – At **Orange** and **Red** maintain at least 1 m from other people, or if this isn't practical it is strongly encouraged to wear a mask.

**Stay home if unwell** – if you have any cold or flu symptoms, stay home and call Healthline on 0800 358 5453 for advice. Speak with your manager.

**APPROVED**

CAR R957162  
Jemal Dixon  
Wellington City Council

atms

07 September 2023

Wash your hands with soap and water often (for at least 20 seconds). Then dry. **OR** use hand sanitiser

Clean and disinfect frequently touched surfaces and objects, such as doorknobs, toilets, gates

**Final Risk Rating:**  
If high or critical, **PAUSE** and check with your manager before proceeding

**Task: What am I doing?**

**Risks: What could go wrong?**

**Controls: How can I do it safely?**

Are the controls in place & working?

Low	Med	High	Crit

<b>The following must be explained by the STMS as part of the site induction</b>	Site Set Up Explained & Roles/Responsibilities Established	Work Zones Established	Exclusion Zones Established	Explained Risks And Controls In Place	Site Entry & Exit Points Established	Evacuation Point Established	Opportunity For Questions/Answers Given
--	--	------------------------	-----------------------------	---------------------------------------	--------------------------------------	------------------------------	---

Full name	Time in	Time out	Phone number	Am I fit and well for work today? Y/N	Do I understand the risk controls and are they in place? Y/N	Have I been inducted onto site & have I advised others of the risks from my work? Y/N	Am I trained and competent and wearing the correct PPE for what I am doing? Y/N	Signature

**APPROVED**  
 CAR R957162  
 Jemal Dixon  
 Wellington City Council  
  
 07 September 2023

<b>Daily On-Site Record</b>  Must be retained for 12 months	TMP Reference _____	Today's Date: ____/____/____							
	TMP Start Date ____/____/____	Risk Sheet Done? Y / N							
	TMP Expiry Date ____/____/____	Timesheet Done? Y / N							
<b>Location Details</b>	Road Name(s)	House Numbers / RP's			Suburb				
<b>Workspace Supervisor</b>	Name	Contact Phone Number		Signature					
<b>STMS</b>			/ /		/ /				
	Name	NZTA ID Number & Qualification	Expiry Date	Signature	Date	Time			
<b>STMS/TMO (Handover)</b>			/ /		/ /				
	Time of handover: _____	NZTA ID Number & Qualification	Expiry Date	Signature	Date	Time			
<b>Closure Type (circle one)</b>	Mobile / Semi-Static / Shoulder / Two Lane Diversion / Stop/Go / Lane / Contraflow / No Entry / Road Closure / Other								
<b>Notifications to Services &amp; Approvals (Refer to TMP for applicable sections &amp; requirements)</b>									
TMP Approved?	Y N N/A	WAP Approved?	Y N N/A	WTOC	Y N N/A	WCCTOC	Y N N/A	Metlink	Y N N/A
Parking Services	Y N N/A	Kiwirail	Y N N/A	Letter Drop Completed	Y N N/A	Emergency Services	Y N N/A	Noise Control	Y N N/A
<b>Temporary Speed Limits</b> <i>It is a legal requirement to accurately record the placement and location of TSL's</i>									
Road Names	RP's / House Numbers		TSL Action	Date	Time	Speed (km/h)	Length (m)		
			Installed	/ /					
			Remains in Place	/ /					
	To (RP/Num)	From (RP/Num)	Removed	/ /					
			Installed	/ /					
			Remains in Place	/ /					
	To (RP/Num)	From (RP/Num)	Removed	/ /					
			Installed	/ /					
			Remains in Place	/ /					
	To (RP/Num)	From (RP/Num)	Removed	/ /					
			Installed	/ /					
			Remains in Place	/ /					
	To (RP/Num)	From (RP/Num)	Removed	/ /					
			Installed	/ /					
			Remains in Place	/ /					
	To (RP/Num)	From (RP/Num)	Removed	/ /					

**APPROVED**  
 CAR R957162  
 Jemal Dixon  
 Wellington City Council  
  
 07 September 2023

## Worksite Monitoring

*Refer to your risk sheet for the frequency of site checks*

Consider the following for your site checklist, this is not an exhaustive list. If you find anything that is not listed, add it to your checklist.

Mobile Closure, Site Install, Site Removal	Site Active	
Are harnesses fitted to vehicles and being used appropriately? Is the truck signage appropriate (TMA, LAS, Arrow board)? Is all gear required for the site is loaded and accounted for? AWWMS or tail pilot has the proper signage? Is there proper distance between vehicles? Are the vehicles positioned in the lane properly? LAS/RD6/AWWMS/VMS/Horizontal arrow boards operating correctly Is the road clear and available for planned work? Are the safety zones maintained from live lane and roll-ahead?	Pedestrians accounted for properly Proper PPE being worn by all on site? Signs positioned as per the TMP? Are there any conflicting signs that need covering? Is the delineation clear and as per the TMP? Are the lane widths appropriate for the speed of traffic? Is the positive TTM implemented appropriate and effective? Is the traffic flowing appropriately? Is property access accounted for? Have the MTC's had a break?	Are pedestrian ramps being used where required? Are any temporary cycle routes clear of clutter and safe to use? Is the detour signage clear and easy to follow? Are the safety zones being adhered to? Have there been any alterations to the TMP not noted? Is the weather on site allowing for the works to continue safely? Is the TSL appropriate? Are drivers following the speed limit? Are the works going to be finished on time?

### Checklist

Items Inspected	Time of Check	Time of Check	Time of Check	Time of Check	Time of Check	Time of Check	Time of Check
	:	:	:	:	:	:	:
Signed by STMS:							

Time Installed	Client on Site	Time	Site Notes
Signature	Date	Time	Site Notes
Time Removed	Client off Site	Time	Site Notes
Signature	Date	Time	Site Notes



### Staff Sign-In

Name	Date	Do I understand the risk controls and are they in place?	Have I been inducted onto site & have I advised others of the risks from my work?	Am I trained and competent and wearing the correct PPE for what I am doing?	Signed

APPROVED

CAR R957162  
Jemal Dixon  
Wellington City Council



07 September 2023

# 1. CC1 Work on berm or footpath - light vehicle parked in carriageway

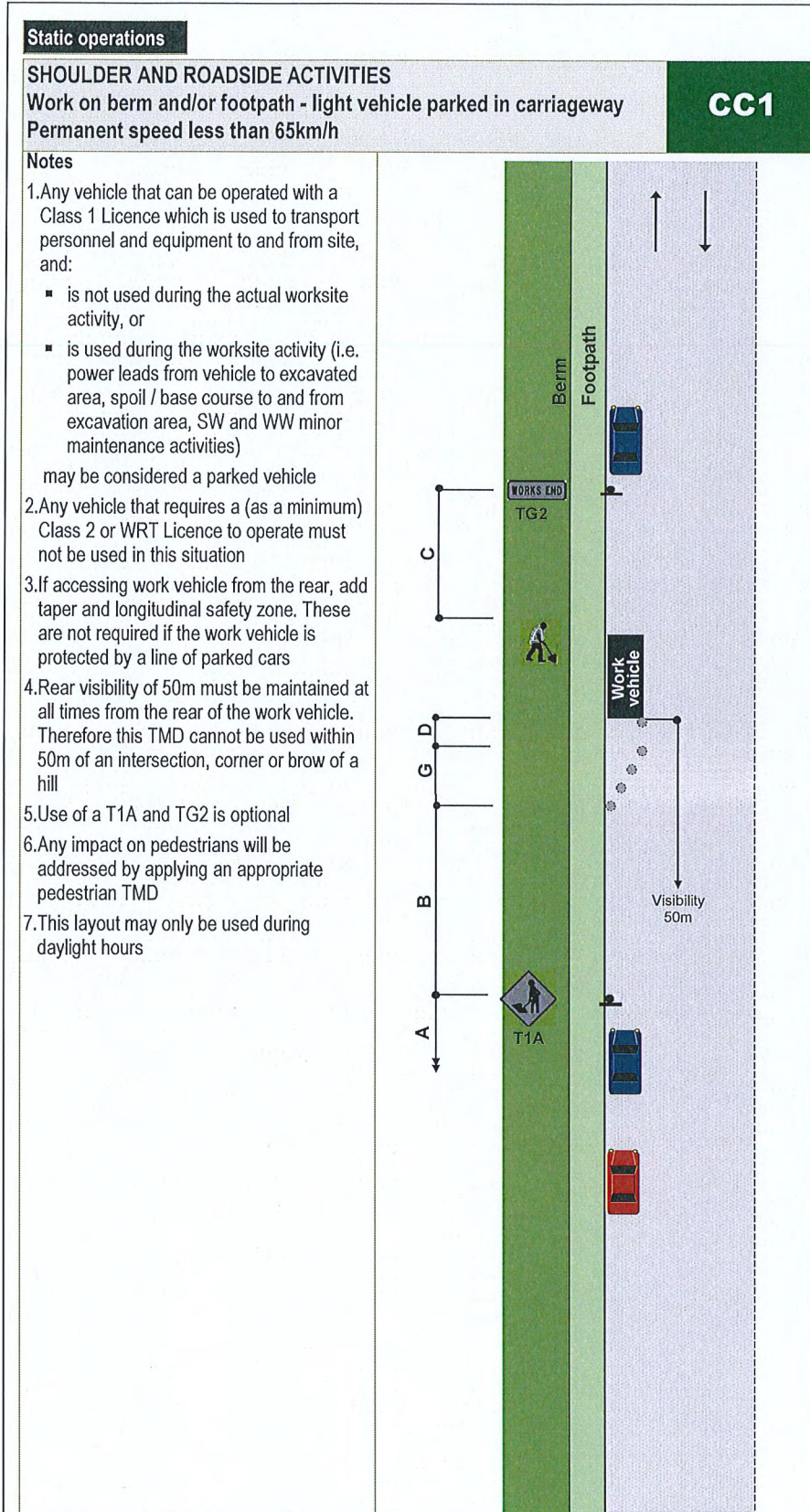

**APPROVED**  
 CAR R957162  
 Jemal Dixon  
 Wellington City Council  
*JR*  
 07 September 2023

## 2. CC2 Traffic not crossing road centre - heavy vehicle parked in carriageway

Static operations	
<p><b>TWO-WAY TWO-LANE ROAD</b>                      Traffic not crossing road centre - heavy vehicle parked in carriageway                      Permanent speed less than 65km/h</p>	
CC2	<p><b>Notes</b></p> <ol style="list-style-type: none"> <li>1. A heavy vehicle is defined as any vehicle that requires (as a minimum) a Class 2 or WRT Licence to operate</li> <li>2. To prevent traffic having to otherwise cross the centre line (and to maintain F), the 1m lateral safety zone and cones along the side of the work vehicle are not required</li> <li>3. If work vehicle can be parked (or partially parked) on the berm, then this is the preferred option</li> <li>4. Driver is to exit and enter the vehicle when the way is clear</li> <li>5. Taper not required if traffic side of work vehicle is inside a line of parked cars (i.e. work vehicle is protected by the line of parked cars)</li> <li>6. If traffic is required to cross the centreline then either TMD F2.13, F2.14, F2.16 or F2.17 will be used</li> </ol>

APPROVED

CAR R957162  
 Jemal Dixon  
 Wellington City Council

[Signature]

07 September 2023



## CC3 Work on berm and/or footpath - work vehicle parked on berm

Static operations

**SHOULDER AND ROADSIDE ACTIVITIES**

Work on berm and/or footpath - work vehicle parked on berm

Permanent speed less than 65km/h

CC3

**Notes**

1. Where contraflow or alternating flow is required if the work vehicle is parked in the carriageway, then the vehicle may instead be parked outside of the carriageway on the front or back berm if the ground surface is firm (not muddy)
2. The vehicle will be parked so that it does not obstruct the normal or safe entry to, or exit from, or movement of other vehicles, or pedestrians within the road reserve
3. Use of a T1A and TG2 is optional
4. Any pedestrian management required will be completed as per TMD F2.1, F2.2, F2.3, CC4 or CC5
5. A safety fence is required around any excavations, falling hazards (e.g. open manhole) or mechanical equipment.
6. Any berm areas affected by the parking of the work vehicle will be reinstated by Wellington Water / City Care with topsoil and grass to the same level as the adjoining berm

APPROVED

CAR R957162  
 Jemal Dixon  
 Wellington City Council

07 September 2023

### 3. CC4 Footpath diverted onto shoulder or parking lane

Static operations

**FOOTPATH**  
Footpath diverted onto shoulder or parking lane

CC4

**Notes**

1. Minimum pedestrian footpath widths:
  - residential / rural - 0.9m
  - suburban centre - 1.2m
  - CBD - 2m
2. Where the length of the temporary footpath exceeds 20m, these widths may have to be increased so footpath users do not have to wait to pass
3. For all attended sites, cones can be used to delineate the edge of the working space and traffic side of the temporary walkway
4. The 1m lateral safety zone between the traffic side of the footpath and the live lane will not be required if the:
  - pedestrian diversion is into a shoulder (including parking lane) of carriageway (and not encroaching into the live lane), or
  - the temporary footpath encroaches into carriageway, but there is good alignment of traffic (taper) past temporary walkway, and
  - site is not on a Main Road (as classified by WCC), a Major or Minor Distributor (as classified by HCC) or a Primary Arterial (as classified by UHCC)
6. Use kerb ramps (or available driveways) to assist mobility vehicles, pushchairs etc
7. A safety fence is required around any excavations, falling hazards (e.g. open manhole) or mechanical equipment
8. This TMD must be used in conjunction with appropriate TTM for any work carried out on the shoulder or in the live lane

The diagram illustrates the layout for diverting a footpath onto a shoulder or parking lane. It shows a road with a central lane and a shoulder. A green rectangular work area is positioned on the shoulder. To the left of the work area, a signpost holds signs T1A (pedestrian crossing), TU32 (footpath diversion), and TU31 (works ahead). A 'WORKS END' sign (TG2) is placed further down the road. Orange traffic cones delineate the temporary footpath on the shoulder and the safety zone. Lane markings include a dashed line for the footpath edge and a solid line for the live lane edge. A vertical scale on the left marks points A, B, C, D, and G. Arrows indicate traffic flow in both directions on the road.

APPROVED

CAR R957162  
Jemal Dixon  
Wellington City Council

07 September 2023

## CC5 Footpath controller guiding pedestrians past the working space

Static operations	
<b>FOOTPATH</b>	CC5
Footpath controller used to guide pedestrians safely past the working space Not to be used on a Main Road as classified by WCC	
<ol style="list-style-type: none"> <li>1. To be used where foot traffic is low (no more than 15 people per hour - 1 person every 4 minutes)</li> <li>2. No footpath directional signs required</li> <li>3. Footpath controller must stop work and guide pedestrians past the working space (providing assistance as required)</li> <li>4. Depending on the volume of foot traffic, an extra person may be required to act as Footpath controller</li> <li>5. For all attended sites, cones can be used to delineate the edge of the working space and traffic side of the temporary walkway</li> <li>6. The 1m lateral safety zone between the traffic side of the footpath and the live lane will not be required if the:                             <ul style="list-style-type: none"> <li>▪ pedestrian diversion is into a shoulder (including parking lane) of carriageway (and not encroaching into the live lane), or</li> <li>▪ the temporary footpath encroaches into carriageway, but there is good alignment of traffic (taper) past temporary walkway, and</li> <li>▪ is not on a Main Road (as classified by WCC), a Major or Minor Distributor (as classified by HCC) or a Primary Arterial (as classified by UHCC)</li> </ul> </li> <li>6. Use kerb ramps (or available driveways) to assist mobility vehicles, pushchairs etc</li> <li>7. A safety fence is required around any excavations, falling hazards (e.g. open manhole) or mechanical equipment</li> <li>8. This TMD may be used in conjunction with other forms of pedestrian management</li> <li>9. This TMD must be used in conjunction with appropriate TTM for any work carried out on the shoulder or in the live lane</li> </ol>	

**APPROVED**  
 CAR R957162  
 Jemal Dixon  
 Wellington City Council  
*JR*  
 07 September 2023

# CC7 - Valve in shoulder or on berm

Mobile operations

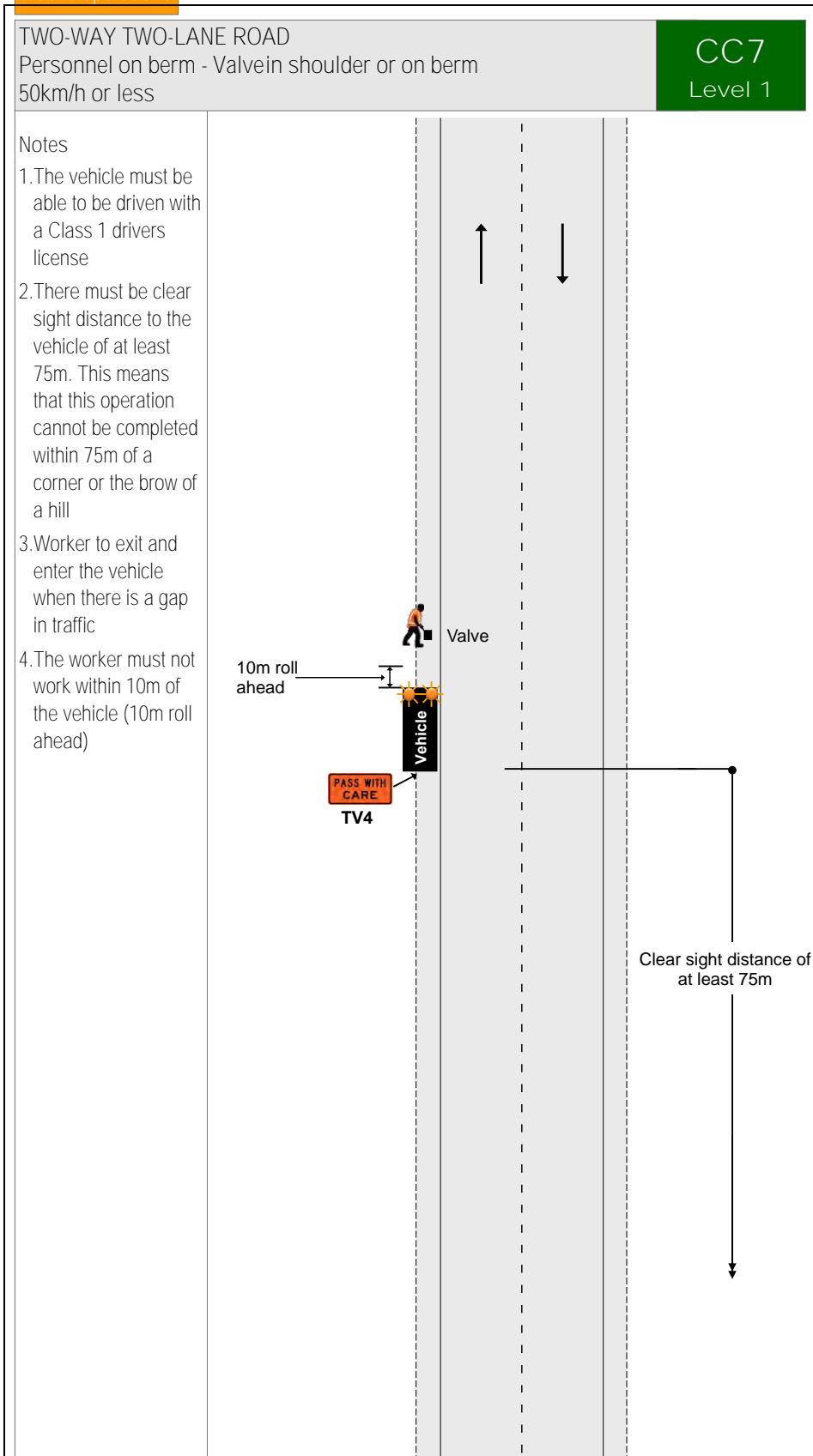

APPROVED

CAR R957162

Jemal Dixon

Mellito City Council

*Jemal Dixon*

07 September 2023

# CC8 - Valve towards left of the lane

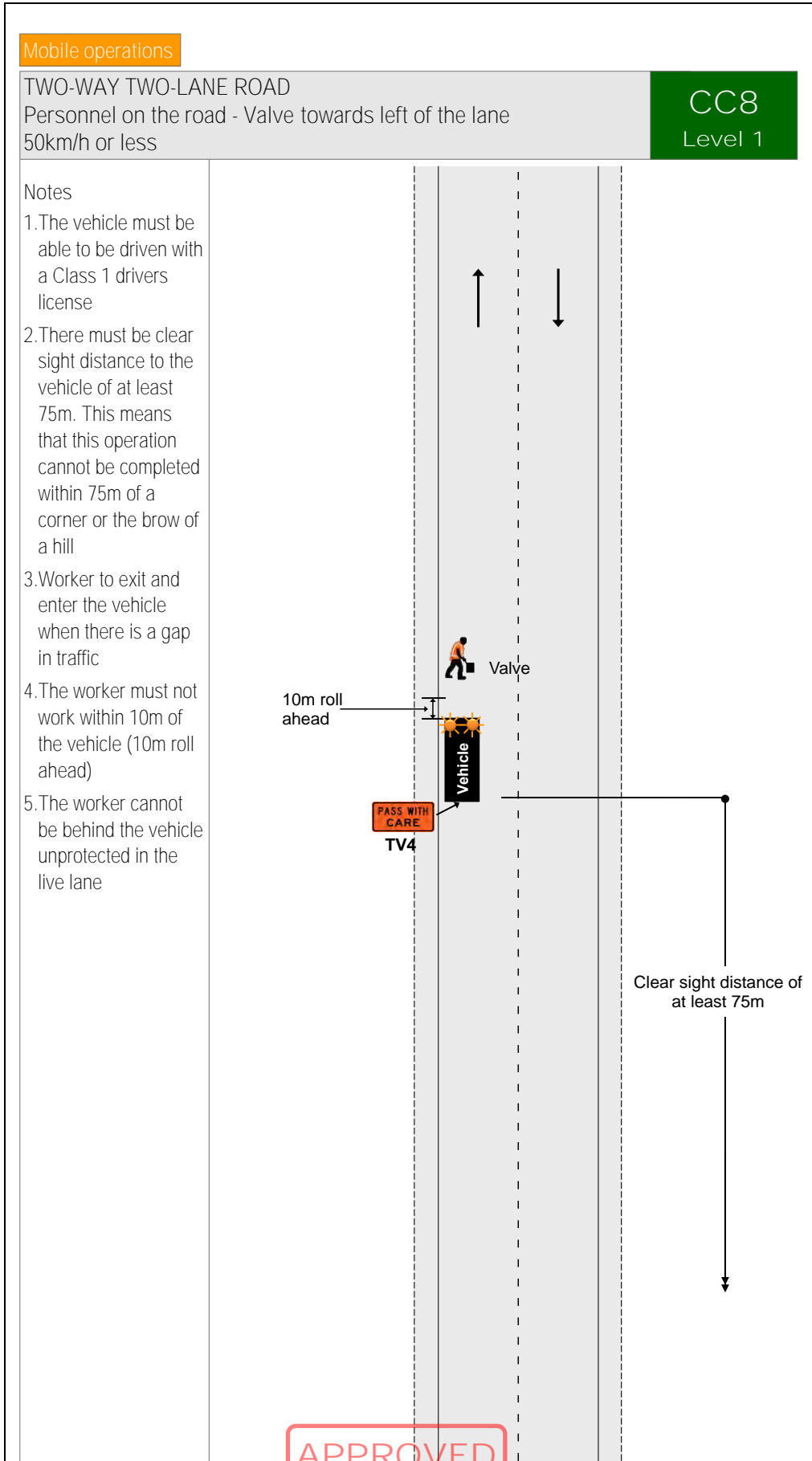

APPROVED

CAR R957162  
Jemal Dixon

Mellisham City Council

*Jemal Dixon*

07 September 2023

# CC9 - Valve towards right of the lane

Mobile operations	
TWO-WAY TWO-LANE ROAD Personnel on the road - Valve towards right of the lane 50km/h or less	
CC9 Level 1	
<p>Notes</p> <ol style="list-style-type: none"> <li>1. The vehicle must be able to be driven with a Class 1 drivers license</li> <li>2. There must be clear sight distance to the vehicle of at least 75m. This means that this operation cannot be completed within 75m of a corner or the brow of a hill</li> <li>3. Worker to exit and enter the vehicle when there is a gap in traffic</li> <li>4. The worker must not work within 10m of the vehicle (10m roll ahead)</li> <li>5. The worker cannot be behind the vehicle unprotected in the live lane</li> <li>6. TG2 WORKS END sign has been omitted for this mobile operation as end of works notification is achieved when road users can no longer see the flashing amber beacons</li> </ol>	

APPROVED

CAR R957162

Internal Document

MILTONS CIVIL CONSULTANTS

[Signature]

07 September 2023

# CC10 - Valve in centre of carriageway

Mobile operations

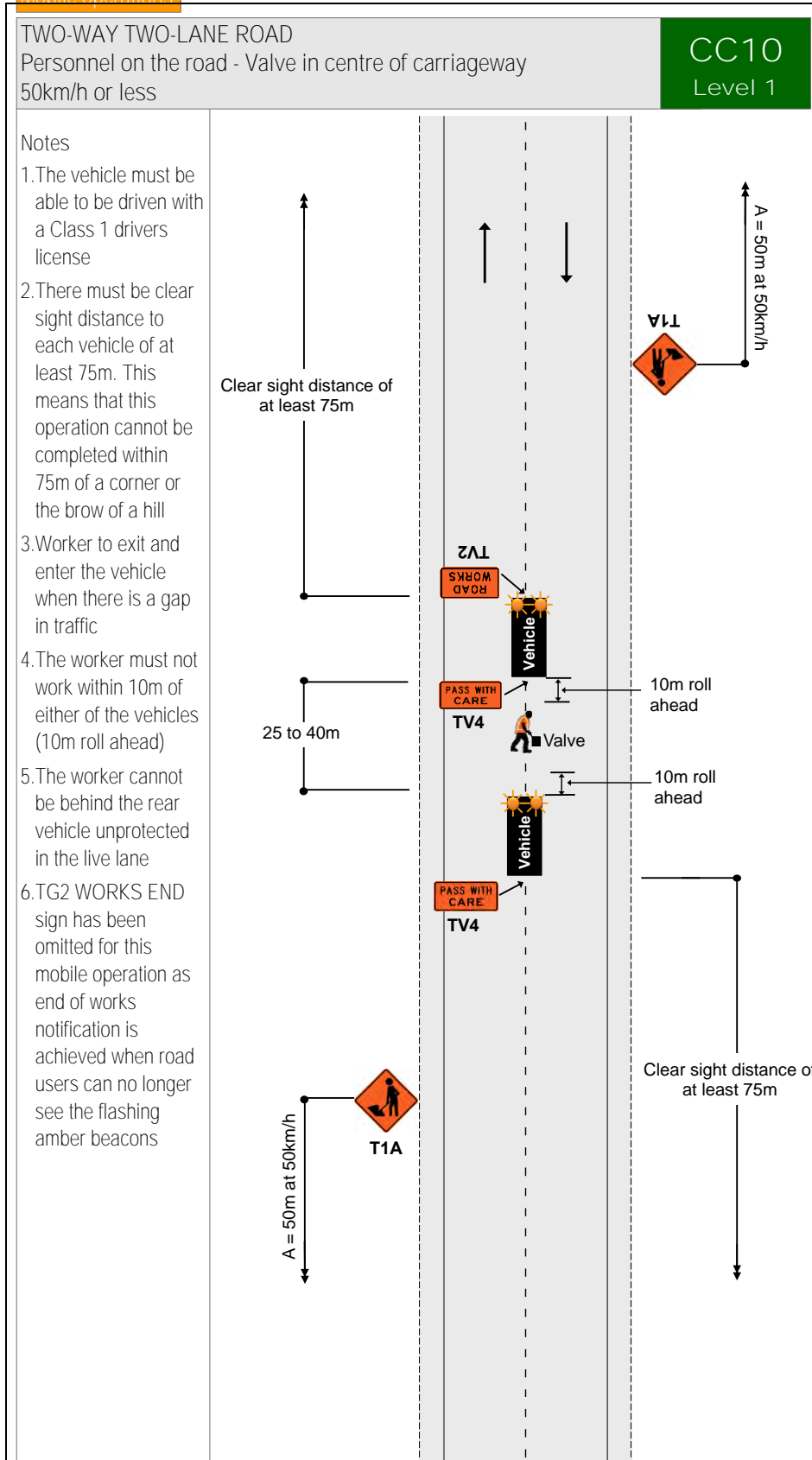

APPROVED

CAR R957162  
Jemal Dixon

Mullumbidgee City Council

*Jemal Dixon*

07 September 2023

# CC11 - Valve in centre of intersection

Mobile operations

TWO-WAY TWO-LANE ROAD  
Personnel on the road - Valve in centre of intersection  
50km/h or less

CC11  
Level 1

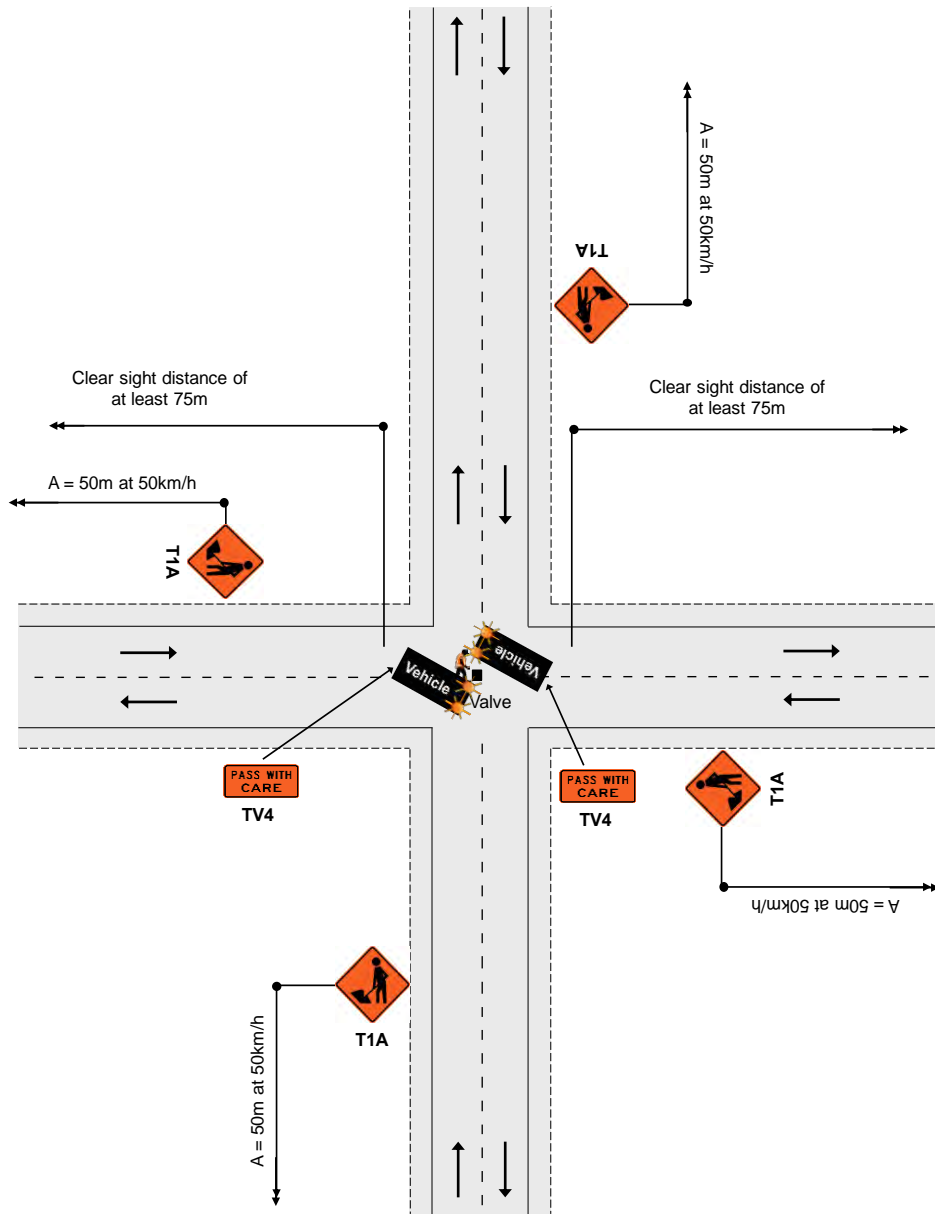

## Notes

1. The vehicles must be able to be driven with a Class 1 drivers license
2. There must be clear sight distance to each vehicle of at least 75m. This means that this operation cannot be completed within 75m of a corner or the brow of a hill
3. Worker to exit and enter the vehicle when there is a gap in traffic
4. The worker cannot be behind the rear vehicle unprotected in the live lane
5. TG2 WORKS END sign has been omitted for this mobile operation as end of works notification is achieved when road users can no longer see the flashing amber beacons

APPROVED

CAR R957162  
Jemal Dixon

ME/Jemal Dixon/City Council

*Jemal Dixon*

07 September 2023



# CC12 - Less than 75m CSD

Mobile operations

TWO-WAY TWO-LANE ROAD  
Less than 75m CSD  
50km/h or less

CC12

Level 1

Notes

1. Where a valve needs to be turned off where there is less than 75m clear sight distance in both directions (eg crest of a hill, on a corner or at a roundabout) then extend the shut off by turning off the nearest valve where 75m clear visibility can be achieved
2. If 50 houses or less are impacted by this extended shut off, then continue with the work activity
3. If more than 50 houses are impacted by this extended shut off, then get the TTM contractor to install TTM to enable the initial valve to be turned off/on safely

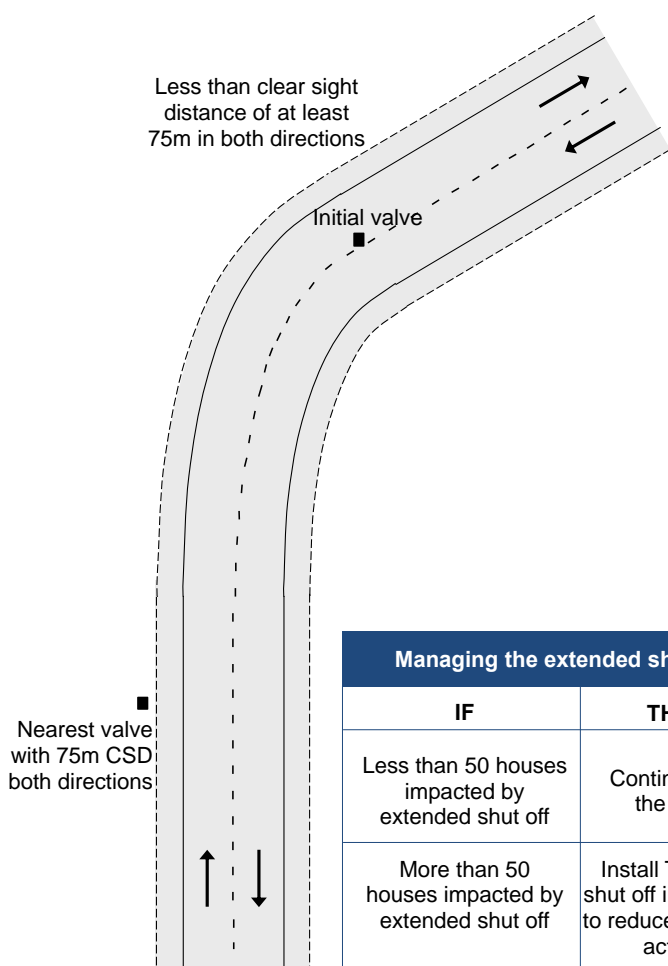

Less than clear sight distance of at least 75m in both directions

Initial valve

Nearest valve with 75m CSD both directions

Managing the extended shut off	
IF	THEN
Less than 50 houses impacted by extended shut off	Continue with the work
More than 50 houses impacted by extended shut off	Install TTM and shut off initial valve to reduce impact of activity

APPROVED

CAR R957162  
Jemal Dixon

Melburn City Council

*Jemal Dixon*

07 September 2023

FOOTPATH

Footpath diverted onto berm behind working space  
First preference

F2.1  
Level 1

Notes

1. Minimum pedestrian footpath widths:
  - Residential/Rural/Suburban Centre - 1.2m
  - CBD - 2m
2. Where the length of the temporary footpath exceeds 20m, these widths may have to be increased so footpath users do not have to wait to pass
3. Temporary footpath surfaces must be suitable for footpath users
4. Use safety fence to enclose the working space, or at attended worksites, cones connected with cone bars can be used to enclose the working space but only for a short period of time  
Note: Cone bars are not recommended where heavy equipment (eg a digger) is being used. A safety fence is preferred in these cases
5. This TMD must be used in conjunction with appropriate TTM for any work carried out on the shoulder or in the live lane

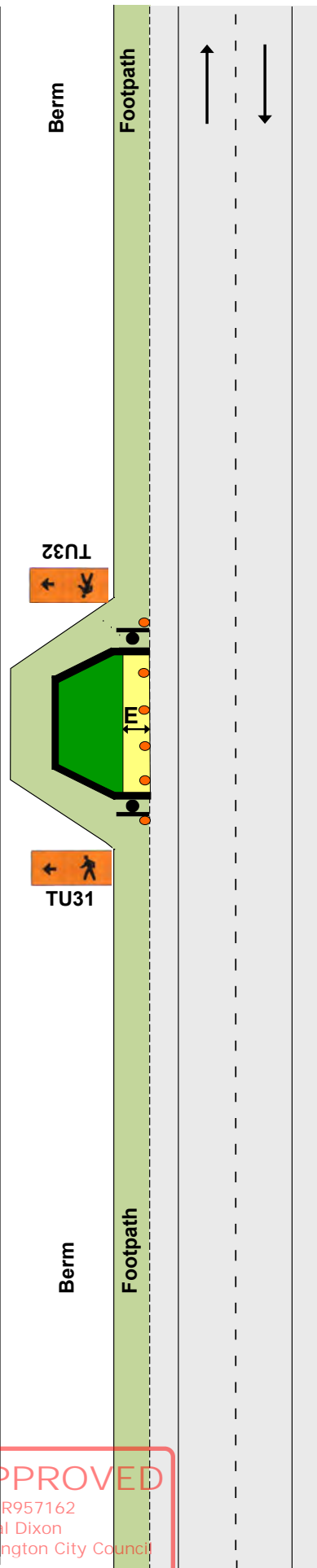

**APPROVED**  
 CAR R957162  
 Jemal Dixon  
 Wellington City Council

FOOTPATH

Footpath diverted onto berm between working space and carriageway  
 Second preference

Notes

1. Minimum pedestrian footpath widths:
  - Residential/Rural/Suburban Centre - 1.2m
  - CBD - 2m
2. Where the length of the temporary footpath exceeds 20m, these widths may have to be increased so footpath users do not have to wait to pass
3. Temporary footpath surfaces must be suitable for footpath users
4. Use safety fence to enclose the working space, or at attended worksites, cones connected with cone bars can be used to enclose the working space but only for a short period of time  
 Note: Cone bars are not recommended where heavy equipment (eg a digger) is being used. A safety fence is preferred in these cases
5. Use barrier or safety fence to delineate the traffic side of the footpath, or at attended worksites cones connected with cone bars can be used to delineate the traffic side of the footpath for a short period of time (not for use on state highways)
6. There must be a lateral safety zone between the traffic side of the footpath and the live lane:
  - 0.5m for barrier
  - 1m for safety fence or cone bars
7. This TMD must be used in conjunction with appropriate TTM for any work carried out on the shoulder or in the live lane

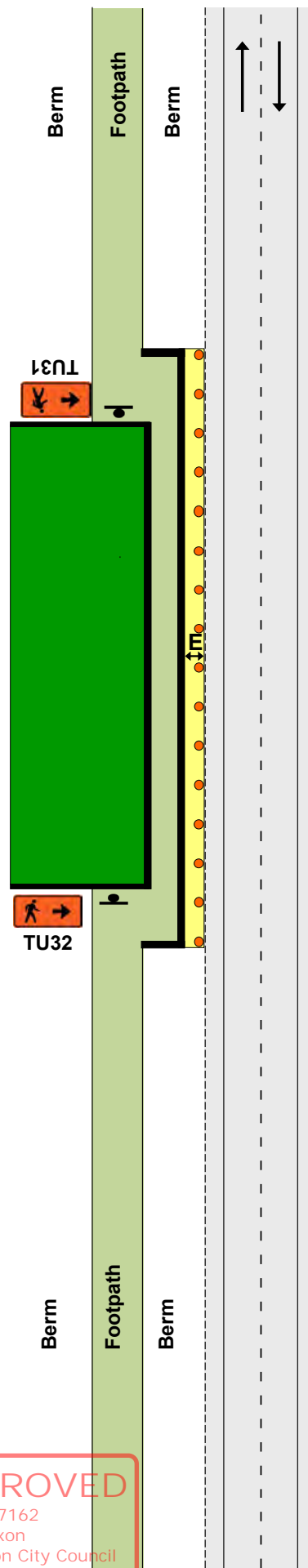

**APPROVED**  
 CAR R957162  
 Jemal Dixon  
 Wellington City Council

FOOTPATH  
Footpath diverted onto carriageway  
Third preference

Notes

1. Minimum pedestrian footpath widths:
  - Residential/Rural/Suburban Centre - 1.2m
  - CBD - 2m
2. Where the length of the temporary footpath exceeds 20m, these widths may have to be increased so footpath users do not have to wait to pass
3. Use safety fence to enclose the working space, or at attended worksites, cones connected with cone bars can be used to enclose the working space but only for a short period of time  
Note: Cone bars are not recommended where heavy equipment (eg a digger) is being used. A safety fence is preferred in these cases
4. Use barrier or safety fence to delineate the traffic side of the footpath, or at attended worksites cones connected with cone bars can be used to delineate the traffic side of the footpath for a short period of time (not for use on state highways)
5. There must be a lateral safety zone between the traffic side of the footpath and the live lane:
  - 0.5m for barrier
  - 1m for safety fence or cone bars
6. Use kerb ramps to assist mobility vehicles, pushchairs, etc
7. At night-time, corners of safety fence may be illuminated with flashing amber warning lights
8. This TMD must be used in conjunction with appropriate TTM for any work carried out on the shoulder or in the live lane

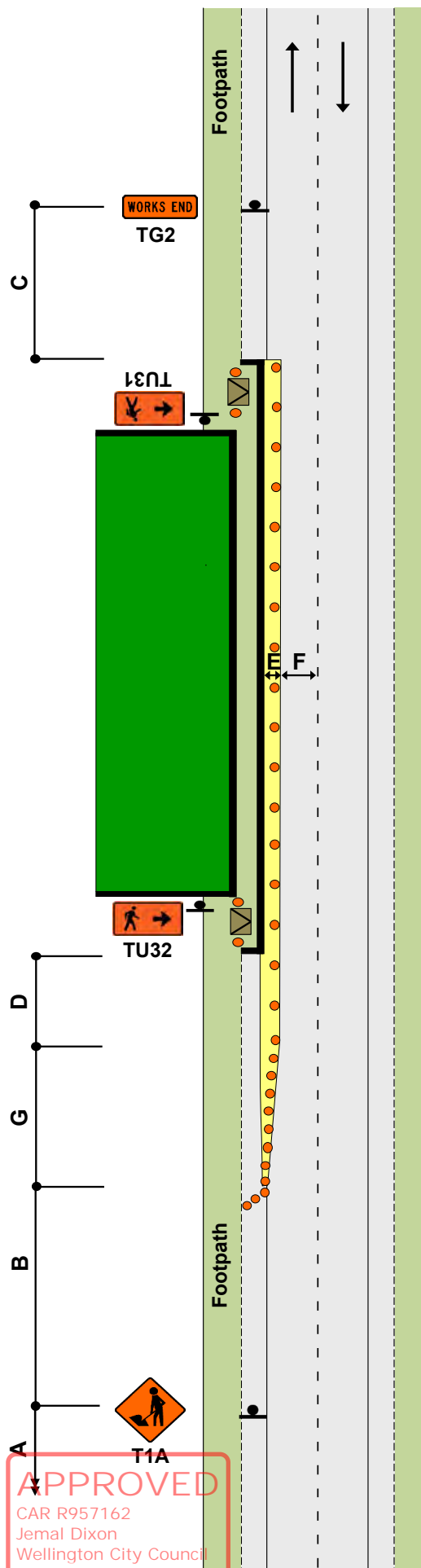

FOOTPATH

Footpath closed - permanent speed less than 65km/h  
Fourth preference

F2.4  
Level 1

Notes

1. Use T2A and PEDESTRIANS supplementary plate to alert road users to the potential of footpath users crossing the carriageway
2. Use safety fence at each end of working space
3. Use kerb ramps
4. Use another TMD as well, where working space/safety zone encroaches on live lane
5. This TMD must be used in conjunction with appropriate TTM for any work carried out on the shoulder or in the live lane

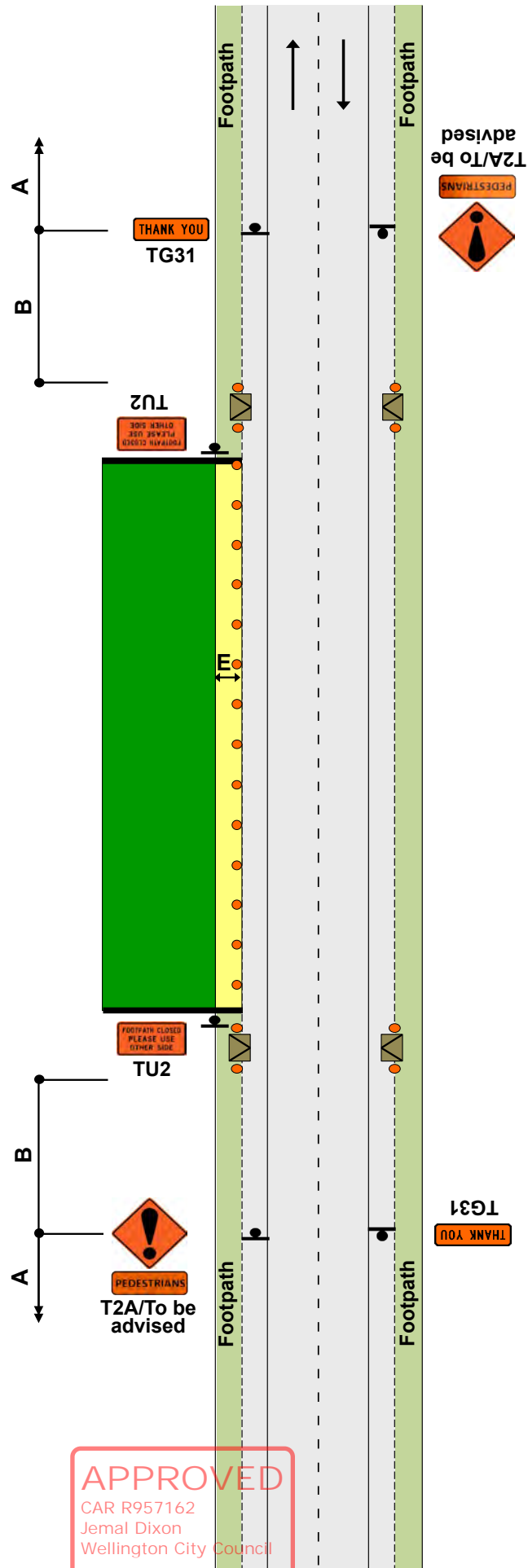

**APPROVED**  
CAR R957162  
Jemal Dixon  
Wellington City Council  
*Jemal Dixon*

SHOULDER AND ROADSIDE ACTIVITIES

Work on berm and/or footpath

Permanent speed less than 65km/h

F2.5  
Level 1

Notes

- 1. Where work is carried out on the berm or footpath and a work vehicle is parked in a legal parallel car park, provided the vehicle is only accessed from the off traffic side, advance warning T1A road works and TG2 WORKS END are optional
- 2. Traffic management must be provided where footpath users or cyclists are affected
- 3. This layout may only be used during daylight hours
- 4. Large plant and machinery must not be used in this situation, a more substantial closure is required

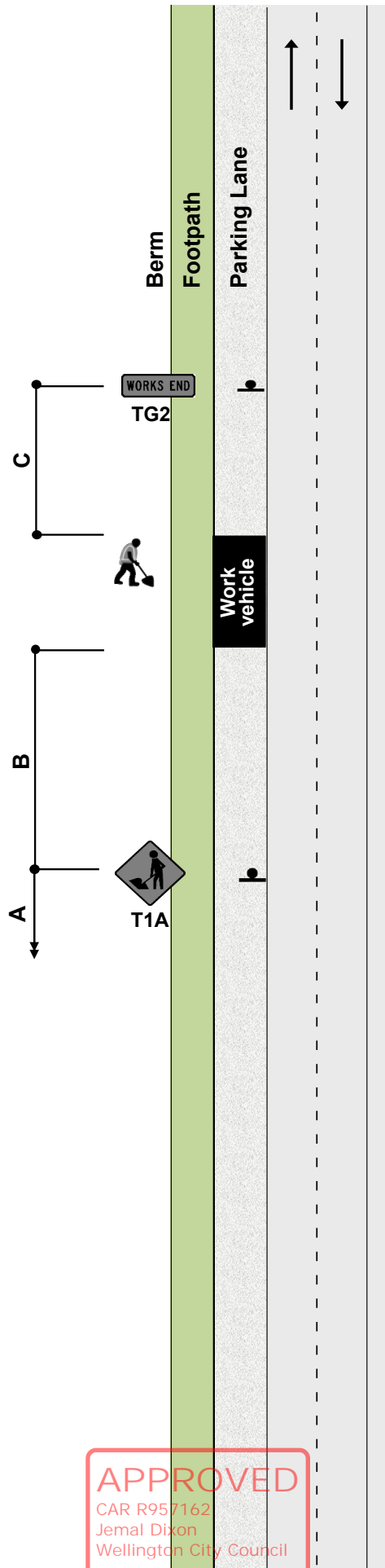

APPROVED  
CAR R957162  
Jemal Dixon  
Wellington City Council  
07 September 2023

SHOULDER AND ROADSIDE ACTIVITIES

Work in parking lane

Permanent speed less than 65km/h

Notes

1. Where work is carried out in the legal parking lane (a place where a vehicle would normally park with a footpath and/or kerb and channel alongside), the following minimum standard of TTM must be provided:

- a 10m taper in front of the work vehicle
- cones alongside the work vehicle and the working space
- a longitudinal safety zone
- a 1m lateral safety zone along the working space
- a T1A (or other appropriate advance warning sign) mounted on the back of the work vehicle

2. T1A road works and TG2 WORKS END signs are optional

3. The work vehicle must be no larger than a light truck and may have an amber flashing beacon

4. Traffic management must be provided where footpath users or cyclists are affected

5. This layout may only be used during daylight hours

6. Large plant and machinery must not be used in this situation, a more substantial closure is required

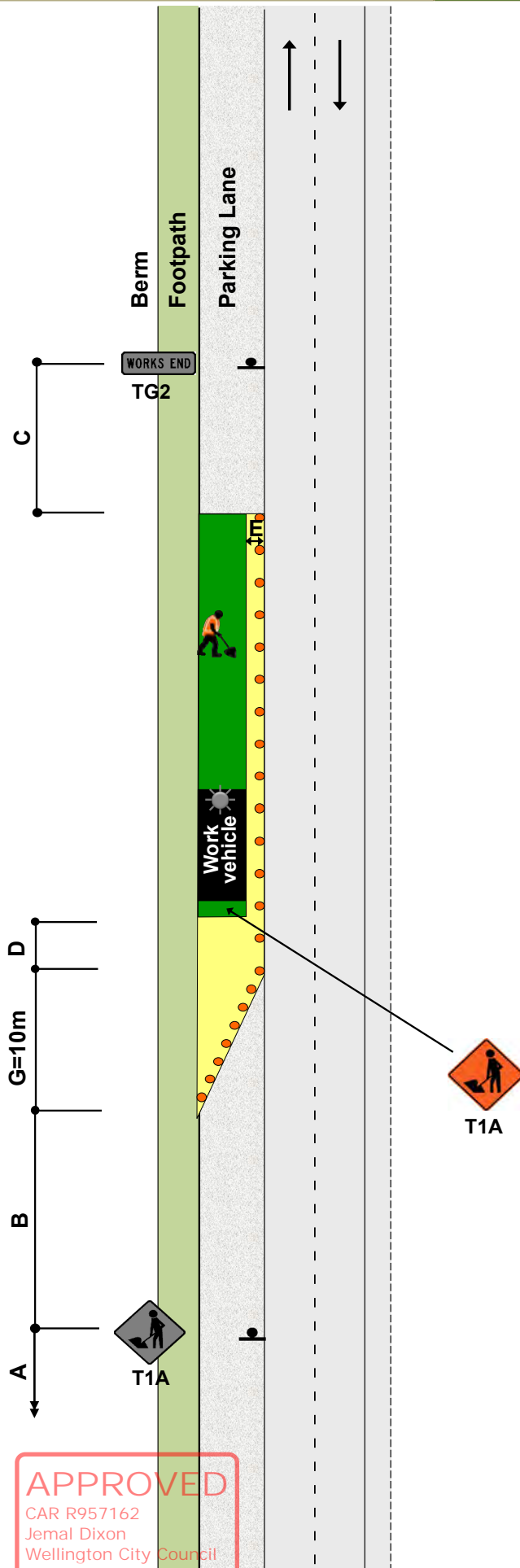

APPROVED  
CAR R957162  
Jemal Dixon  
Wellington City Council

Notes

1. A 10m taper is allowed where shoulder width is less than 2.5m

2. \*For shoulders exceeding 2.5m width, apply the following calculation; calculation of taper length for lateral shift of less than 3.5m is:

$W \times G$

3.5

W = Width of shoulder

G = Taper length in metres from the level 1 layout distance table

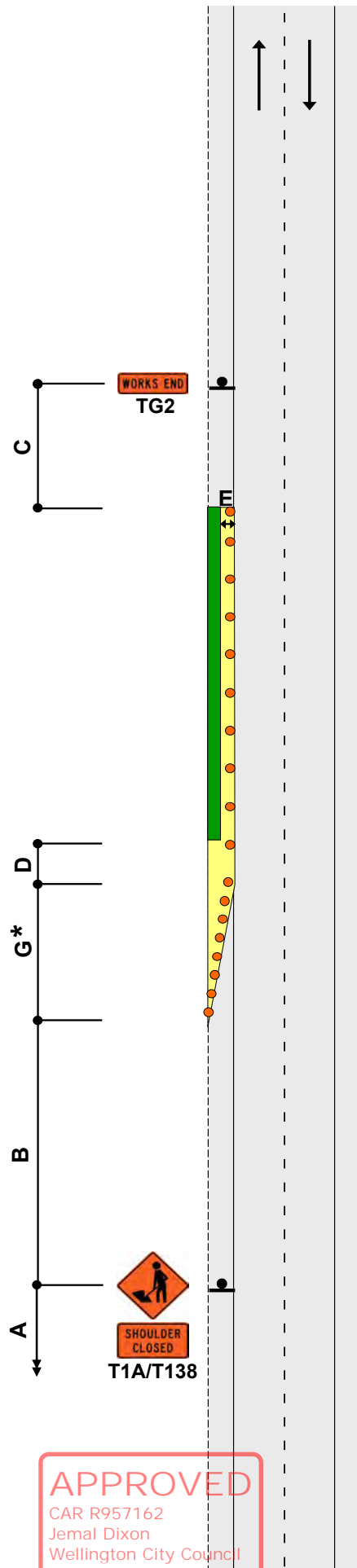

**APPROVED**  
 CAR R957162  
 Jemal Dixon  
 Wellington City Council

*Jemal Dixon*



Notes

1.\*Calculation of taper length for lateral shift of less than 3.5m is:

$$\frac{W \times G}{3.5}$$

3.5

W = Width of lateral shift

G = Taper length in metres from the level 1 layout distance table

2.If traffic likely to cross the centreline, place cones on the centreline with RD6L signs at each end

3.Use TSLs if required by TSL decision matrix

4.If TSLs not required, the T1A and TG2 signs on the right hand side of the road are also not required

5.The T144 X0km/h AHEAD sign is optional

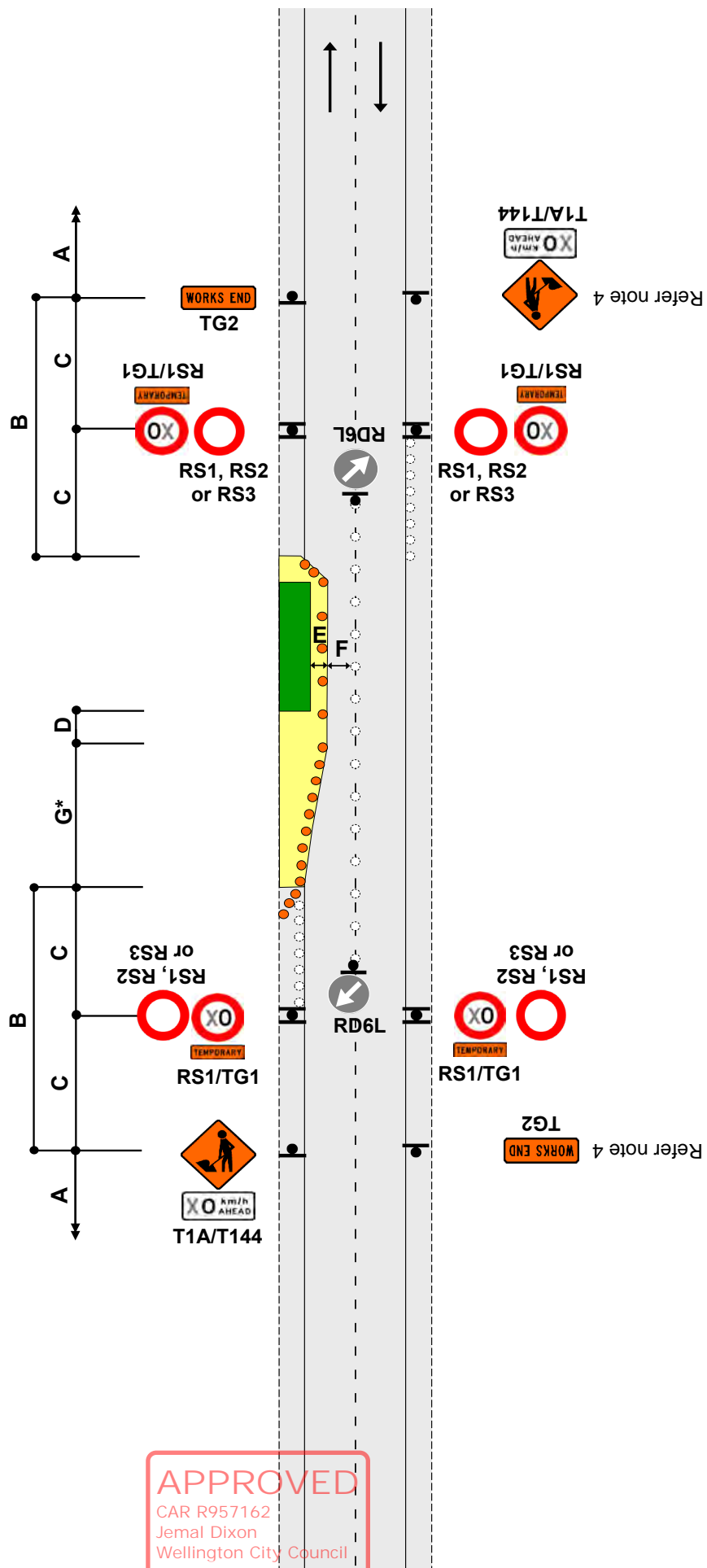

Notes

1. Use this diagram if signs will not be visible on left-hand side of road, or if it is safer to place signs on median and this will not interfere with turning traffic movements
2. Where a median exists which is more than 2m wide, the signs may be positioned on the median. Signs must be placed back-to-back unless on a solid median
3. Where there is a solid median, signs are not required in the opposing direction
4. \*Calculation of taper length for lateral shift of less than 3.5m is:  
$$\frac{W \times G}{3.5}$$
  
W = Width of lateral shift  
G = Taper length in metres from the level 1 layout distance table
5. Use TSLs if required by TSL decision matrix
6. The T144 X0km/h AHEAD sign is optional

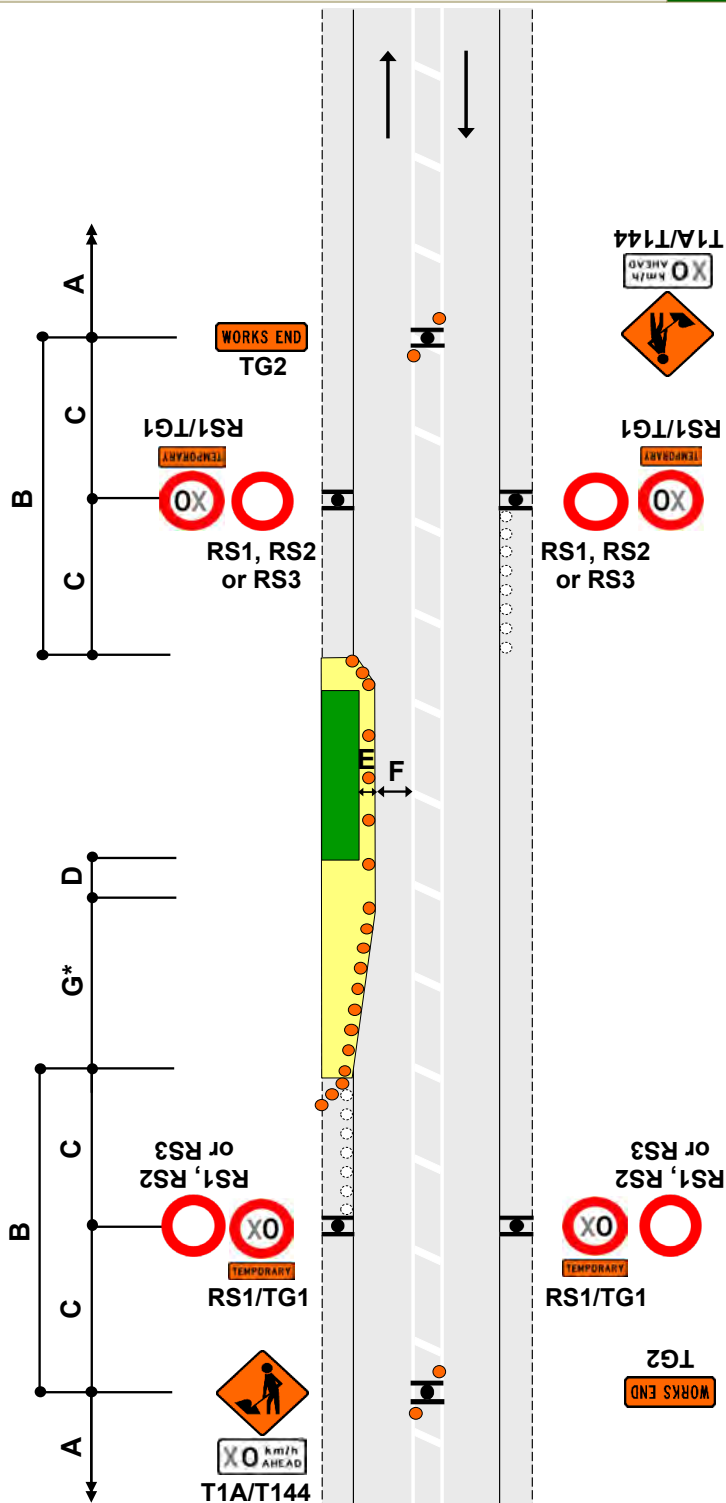

APPROVED  
CAR R957162  
Jemal Dixon  
Wellington City Council

Notes

1. Cones are required on edge of the temporary lane opposite closure if road is not well defined
2. Return taper at end of closure may be shortened
3. \*Calculation of taper length for lateral shift of less than 3.5m is:  
$$\frac{W \times G}{3.5}$$
  
W = Width of lateral shift  
G = Taper length in metres from the level 1 layout distance table
4. To allow heavy vehicles to manoeuvre, cones in the channel must be offset by at least 10m where the direction changes. Refer C8.2.12
5. Use PN11 No Stopping signs, if necessary
6. Use TSLs if required by TSL decision matrix
7. The T144 X0km/h AHEAD sign is optional

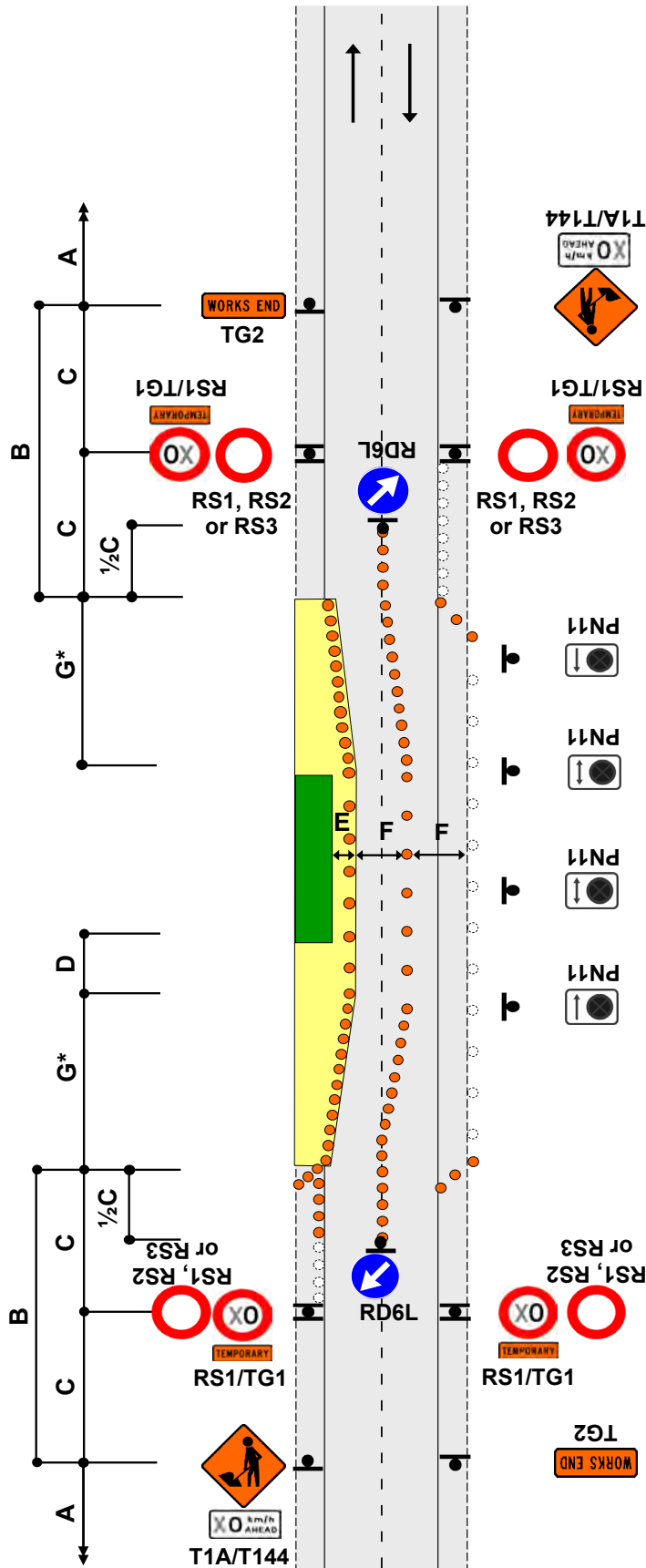

APPROVED

CAR R957162  
Jemal Dixon  
Wellington City Council

Notes

1. Extend or place extra advance warning signs towards on-coming traffic beyond any expected traffic queues
2. A 30m return taper at the end of the closure is mandatory
3. Cones are required on edge of the temporary lane opposite closure if road is not well defined
4. To allow heavy vehicles to manoeuvre, cones in the channel must be offset by at least 10m where the direction changes. Refer C8.2.12
5. Use PN11 no stopping signs, if necessary
6. MTC with RP4/RP41 STOP/GO or RP4/RP42 STOP/SLOW paddle on road shoulder located between 1st and 2nd cone in the cone threshold closest to the working space
7. Minimum 5 cones in cone threshold at:
  - 2.5m centres - less than 65km/h
  - 5m centres - more than 65km/h
8. Refer to C10.2.3 MTC essentials for further information
9. Delays cannot exceed the time approved by the RCA (normally 5 to 10 minutes)
10. The T144 30km/h AHEAD sign is optional

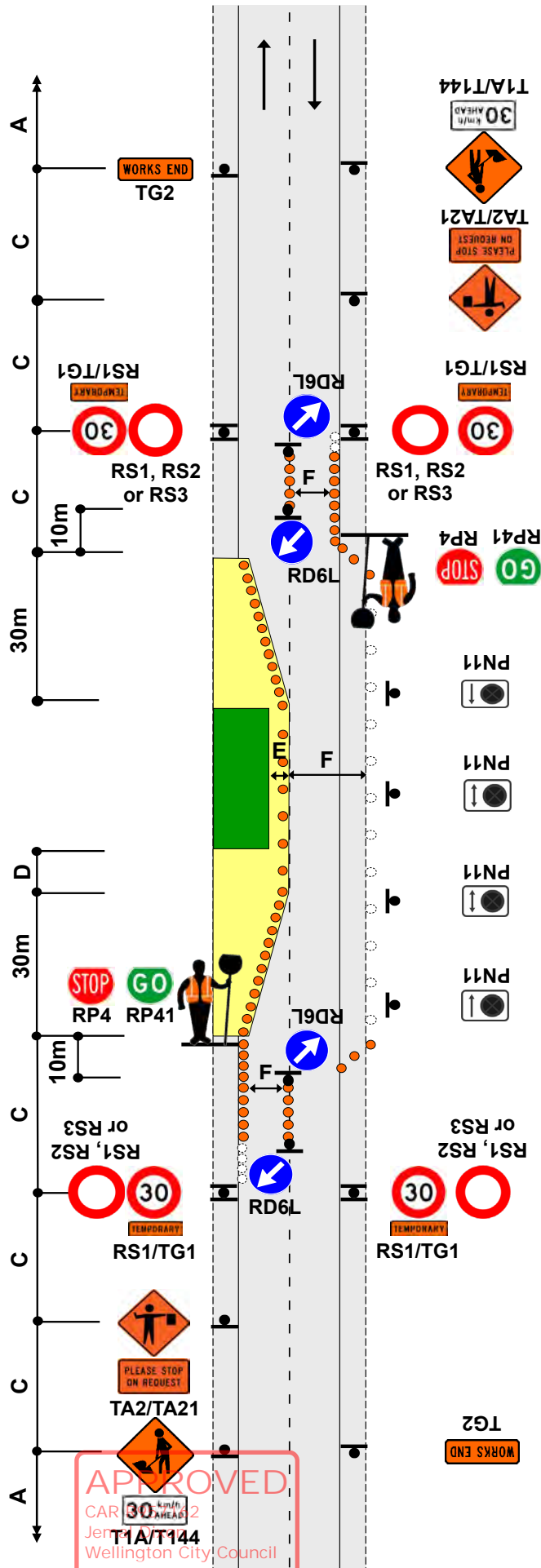

TWO-WAY TWO-LANE ROAD  
 All traffic stopped temporarily  
 Manual traffic control (STOP/GO or STOP/SLOW)

- Notes
1. Closure period not to exceed the limit set or approved by the RCA
  2. Extend advance warning signs towards on-coming traffic beyond any expected traffic queues
  3. MTC with RP4/RP41 STOP/GO or RP4/RP42 STOP/SLOW paddle on road shoulder located between 1st and 2nd cone in the cone threshold closest to the working space
  4. Minimum 5 cones in cone threshold at:
    - 2.5m centres - less than 65km/h
    - 5m centres - more than 65km/h
  5. MTCs must show same message to oncoming traffic (eg STOP/STOP or GO/GO)
  6. Refer to C10.2.3 MTC essentials for further information
  7. When road users are passing the working space in alternating flow, all construction equipment must be stopped on same side of the road if there is no separation from the live lane
  8. Where damage is likely to occur to passing traffic eg during sealing, traffic must be stopped in both directions
  9. The T144 X0km/h AHEAD sign is optional

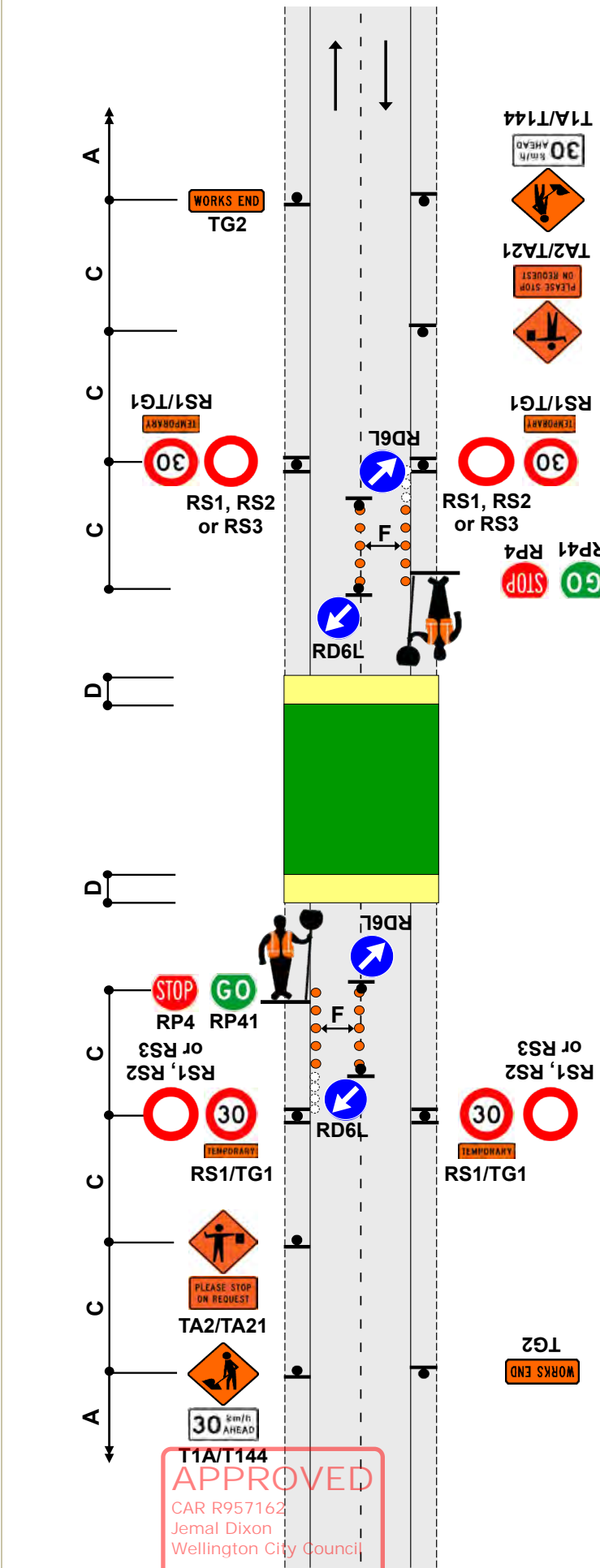

T1A/T144  
**APPROVED**  
 CAR R957162  
 Jemal Dixon  
 Wellington City Council

TWO-WAY TWO-LANE ROAD  
 Single-lane (traffic volume less than 1000vpd - 80vph)  
 Give way control

F2.16  
 Level 1

Notes

- The RP51/RP22 and RP52 controls must be placed in the following priority order:
  - downhill traffic must give way to uphill traffic
  - traffic that has to cross into the opposing lane gives way, however where visibility for this vehicle is marginal the contractor may require the other vehicle with better visibility to give way
- Intervisibility is required as indicated on diagram. This means that a vehicle at one sign is able to see whether the way ahead is clear
- A 30m return taper at the end of the closure is mandatory
- Use PN11 No Stopping signs, if necessary
- Cones are required on edge of the temporary lane opposite closure if road is not well defined
- The T144 X0km/h AHEAD sign is optional

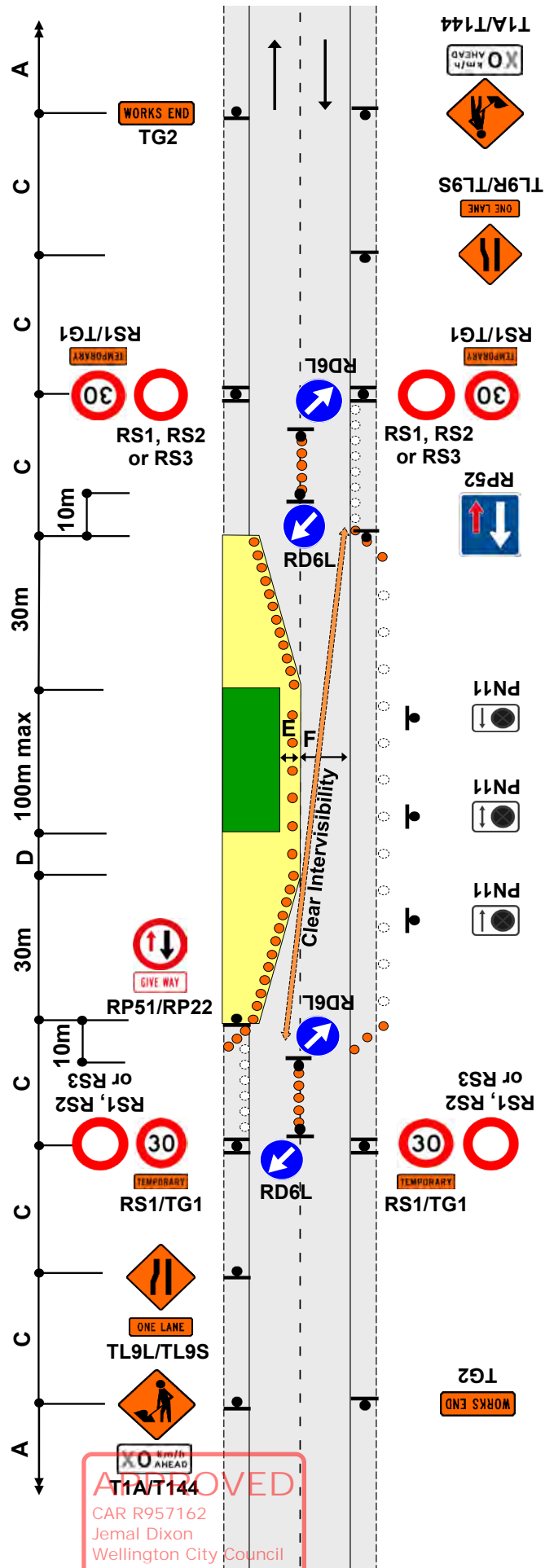

APPROVED  
 CAR R957162  
 Jemal Dixon  
 Wellington City Council

- Notes
1. Provide details of make and model of portable traffic signals in the TMP
  2. Install temporary limit lines (must be able to be removed upon completion) or use RP61/RP62 signs
  3. Approved temporary speed humps may also be used. Consider use of MTC while speed humps are installed
  4. A 30m return taper at the end of the closure is mandatory
  5. Cones are required on edge of the temporary lane opposite closure if road is not well defined
  6. Extend or place extra advance warning signs towards on-coming traffic beyond any expected traffic queues
  7. Use PN11 No Stopping signs, if necessary
  8. Minimum 5 cones in cone threshold at:
    - 2.5m centres - less than 65km/h
    - 5m centres - more than 65km/h
  9. The T144 30km/h AHEAD sign is optional

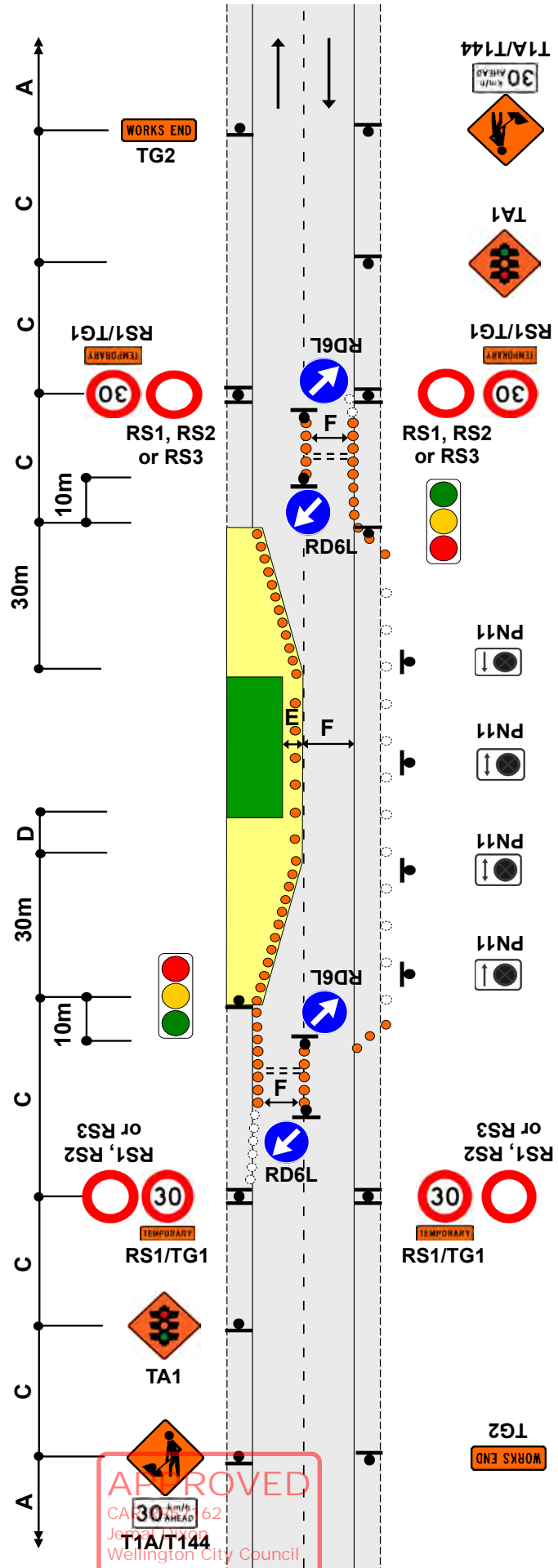

APPROVED  
 CA 30 AHEAD 62  
 Wellington City Council

Notes

1. Cones are required on edge of the temporary lane opposite closure if road is not well defined
2. \*Calculation of taper length for lateral shift of less than 3.5m is:  
$$\frac{W \times G}{3.5}$$
  
W = Width of lateral shift  
G = Taper length in metres from the level 1 layout distance table
3. Use PN11 no stopping signs, if necessary
4. Use TSLs if required by TSL decision matrix
5. The T144 X0km/h AHEAD sign is optional

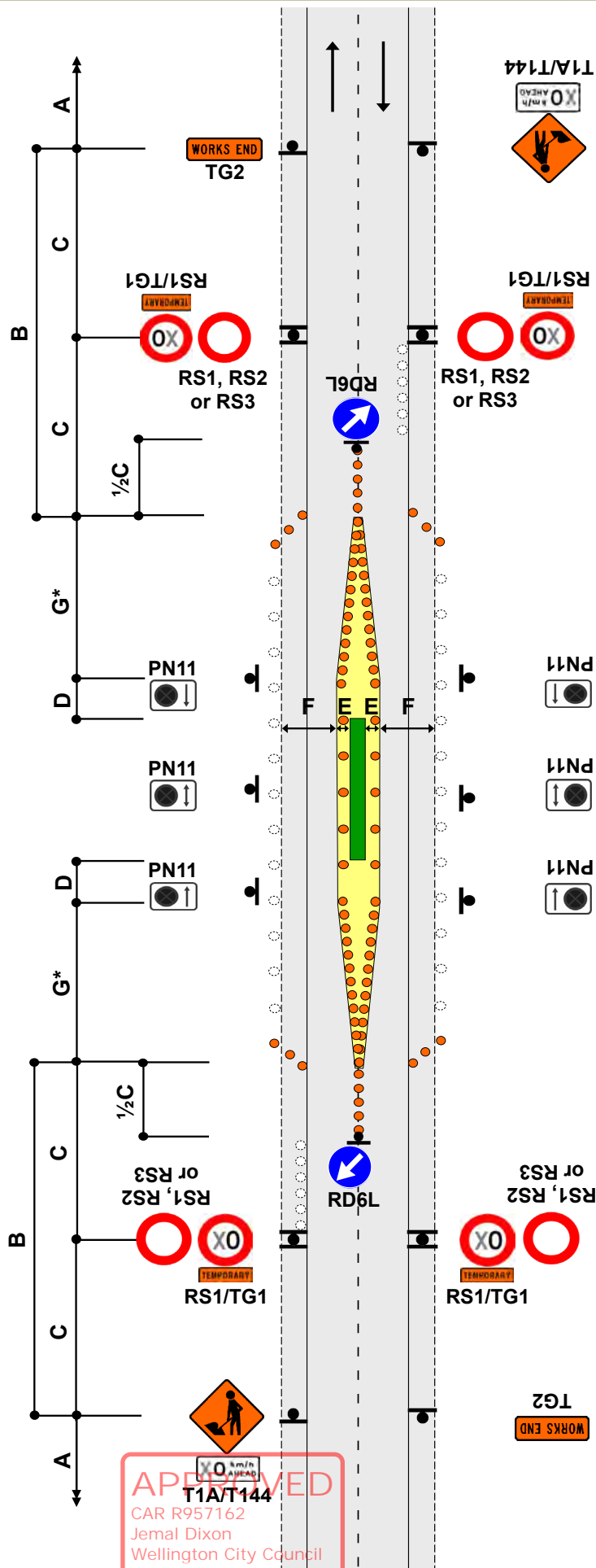

APPROVED  
CAR R957162  
Jemal Dixon  
Wellington City Council



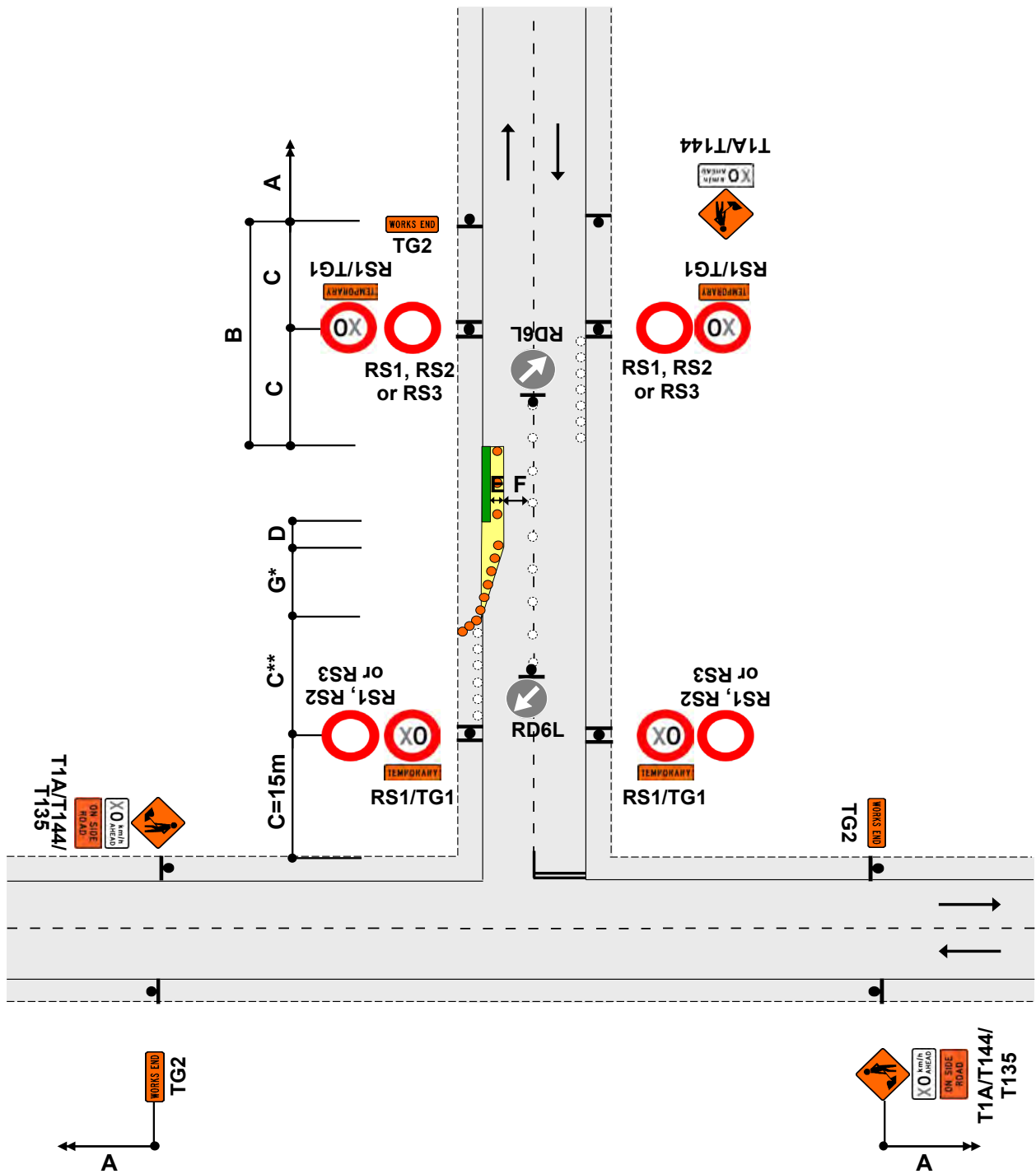

- Notes
1. Sign spacing of TSL at the intersection can be reduced as per the table shown below
  2. Where minimum dimensions cannot be achieved TMD F2.20 is to be used
  3. Advance warning signs on main road must be at least the warning distance away from first cone in taper
  4. \*Calculation of taper length for lateral shift of less than 3.5m is:  

$$\frac{W \times G}{3.5}$$
 W = Width of lateral shift  
 G = Taper length in metres from the level 1 layout distance table
  5. If traffic likely to cross the centreline, place cones on the centreline with RD6L signs at each end
  6. Use TSLs as required by TSL decision matrix
  7. The T144 30km/h AHEAD sign is optional

**APPROVED**  
 CAR R957162  
 Jemal Dixon  
 Wellington City Council

Speed (PSL)	Intersection to TSL	TSL to taper	Total
<50km/h	15m	15m	30m
60km/h	15m	25m	40m
>70km/h	15m	40m	55m

TWO-WAY TWO-LANE ROAD - Intersection or roundabout  
 Road works on side road after intersection - TSL on main road  
 Traffic not crossing road centre

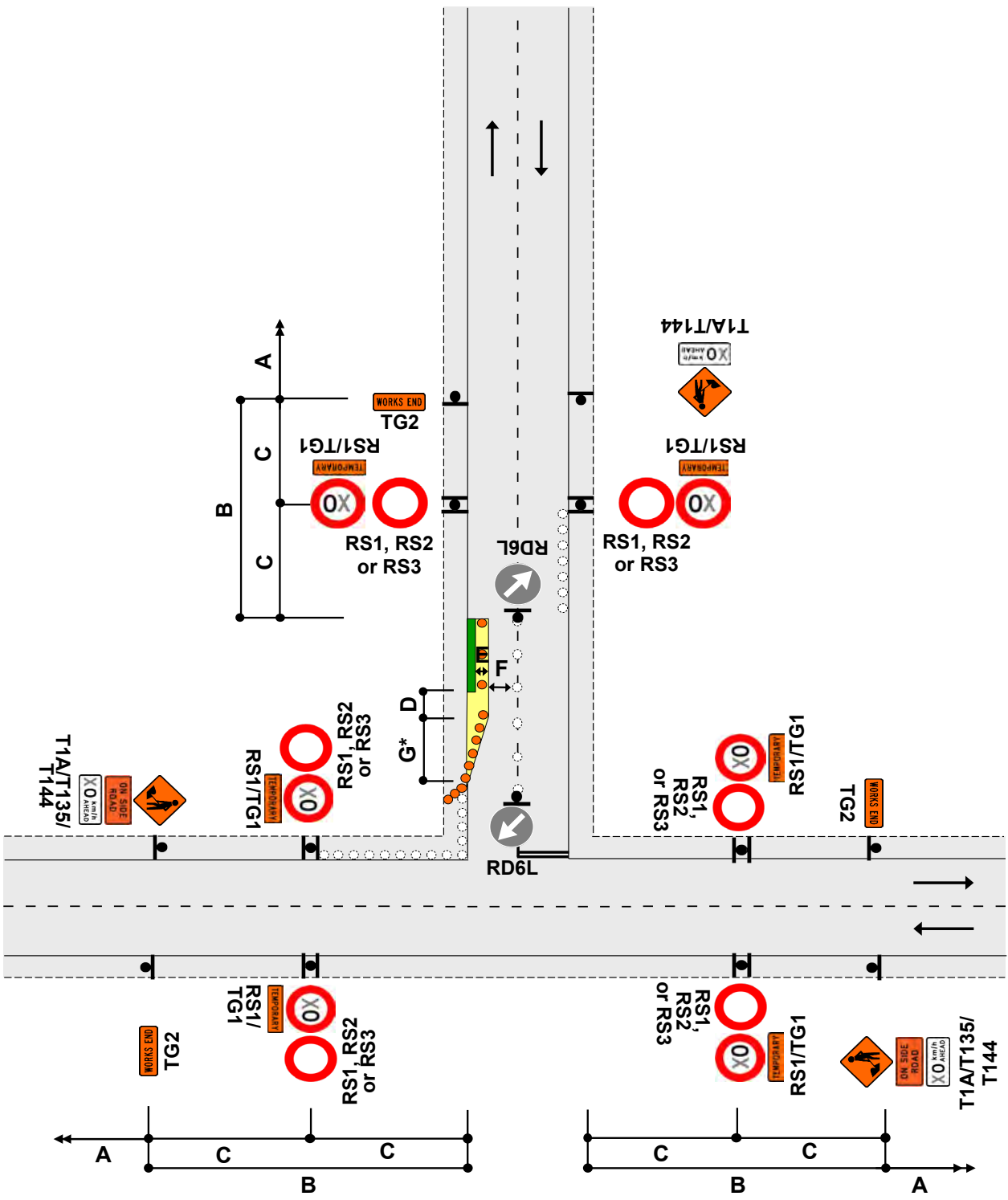

Notes

- \*Calculation of taper length for lateral shift of less than 3.5m is:  

$$\frac{W \times G}{3.5}$$
 W = Width of lateral shift  
 G = Taper length in metres from the level 1 layout distance table
- If traffic likely to cross the centreline, place cones on the centreline with RD6L signs at each end
- Use TSLs as required by TSL decision matrix
- The T144 X0km/h AHEAD sign is optional

**APPROVED**  
 CAR R957162  
 Jemal Dixon  
 Wellington City Council

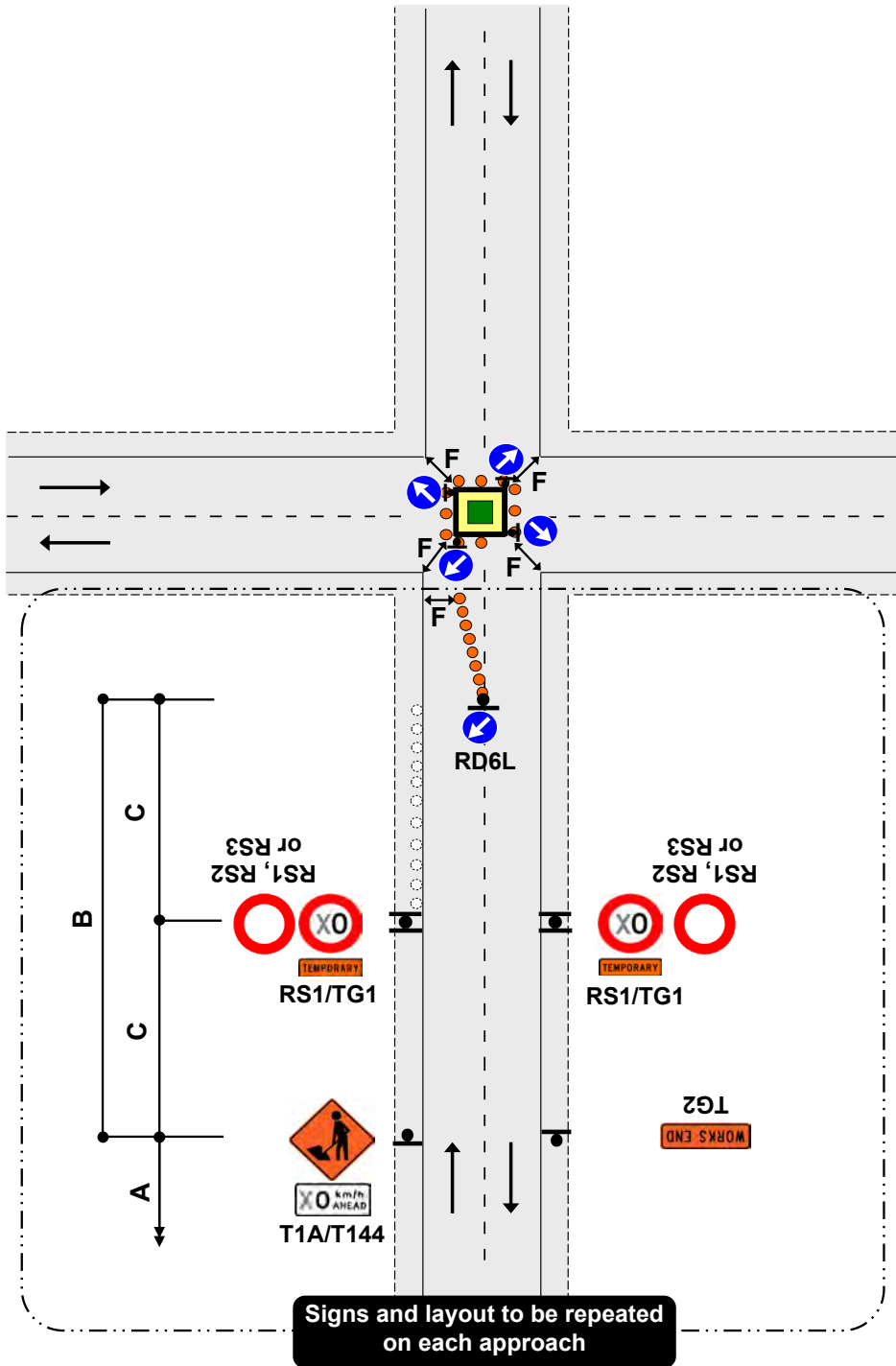

Notes

1. This diagram may be used at a T intersection by removing any one of the roads
2. Signs and layout shown in the box at the bottom of the diagram is to be repeated on each approach
3. RD6L signs are not required at an existing roundabout
4. Cone tapers are optional at existing roundabouts
5. Lane widths, F, may need to be increased to allow for turning movements of larger vehicles
6. Use TSLs if required by TSL decision matrix
7. The T144 X0km/h AHEAD sign is optional

**APPROVED**  
CAR R957162  
Jemal Dixon  
Wellington City Council

TWO-WAY TWO-LANE ROAD - Intersection or roundabout  
 Closure at corner of an intersection  
 Manual traffic control (Stop/Go or Stop/Slow)

F2.22  
 Level 1

Notes

1. This diagram may be used at a T intersection by removing any one of the roads
2. Signs and layout shown in the box at the bottom of the diagram is to be repeated on each approach
3. A 30m return taper at the end of the closure is mandatory
4. Use PN11 no stopping signs, if necessary
5. MTC with RP4/RP41 STOP/GO or RP4/RP42 STOP/SLOW paddle on road shoulder located between 1st and 2nd cone in the cone threshold closest to the working space
6. Minimum 5 cones in cone threshold at:
  - 2.5m centres - less than 65km/h
  - 5m centres - more than 65km/h
7. Refer to C10.2.3 MTC essentials for further information
8. On roads with a permanent speed limit of 100km/h, cones are required from the TSL to the taper if the speed is reduced by more than 30km/h
9. The T144 30km/h AHEAD sign is optional

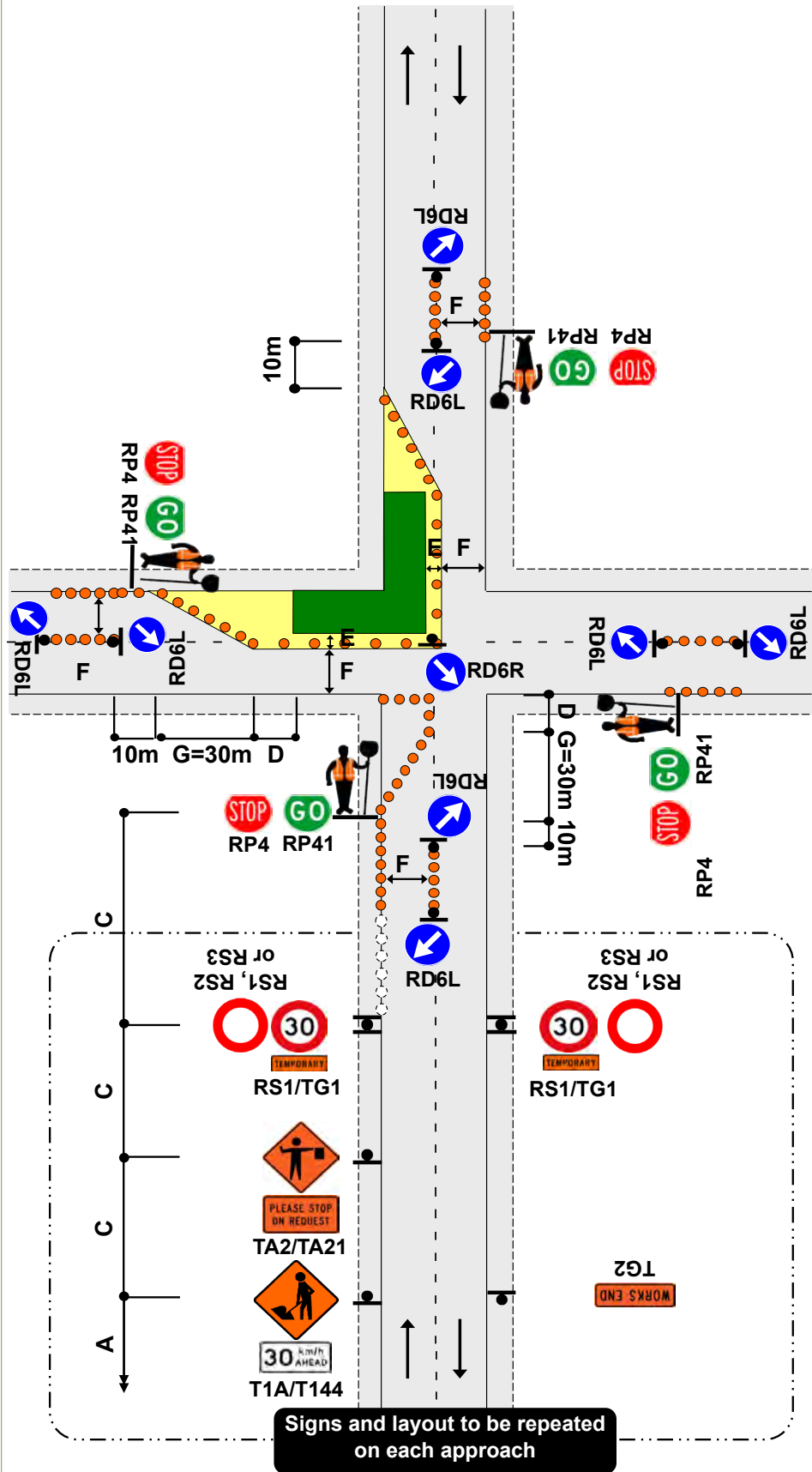





**APPROVED**  
 CAR R957162  
 Jemal Dixon  
 Wellington City Council

Notes

1. This diagram is for initial response only. Appropriate long term TTM must be installed as soon as practical

2. Use one of the following signs and/or supplementary plates:

T211		Flooding
T212		Washout
TR1L/R		Slips
TR2		Slippery Surface
TR4		Uneven Surface

3. If necessary, erect TG4 DRY YOUR BRAKES sign

4. Delineate hazard if hazard extends onto lane

5. Use TSLs if required by TSL decision matrix

6. The T144 X0km/h AHEAD sign is optional

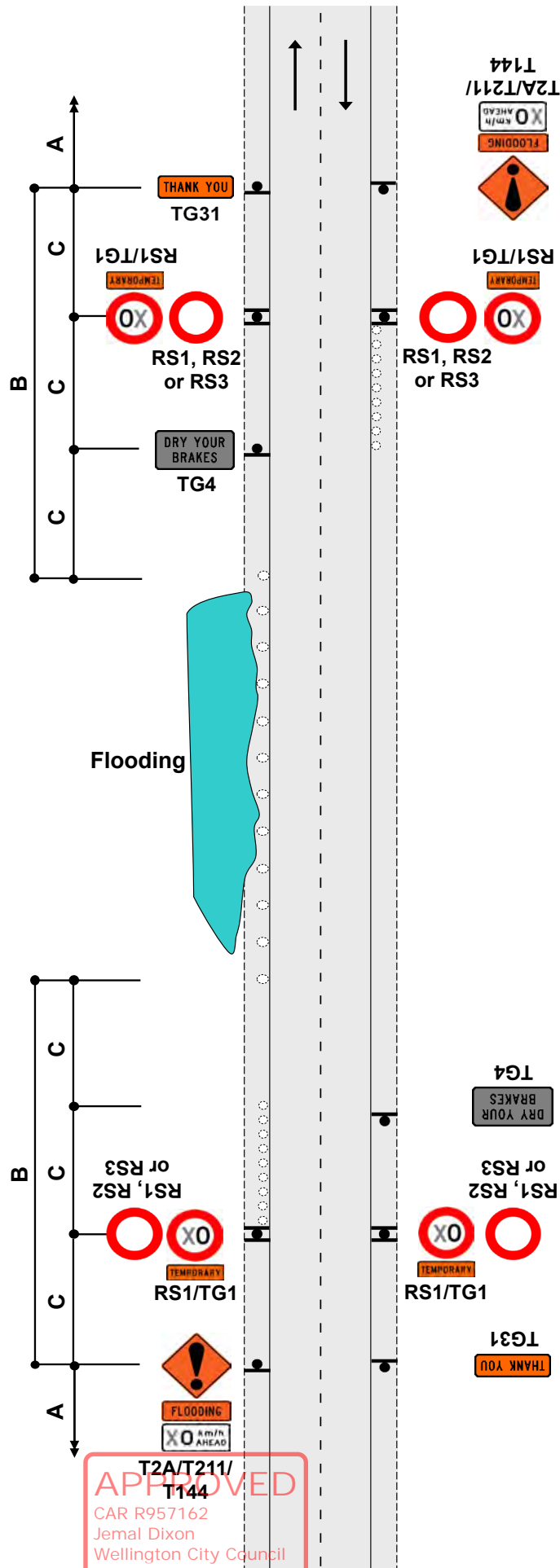

APPROVED  
 CAR R957162  
 Jemal Dixon  
 Wellington City Council

07 September 2023

Notes

1. Use TSLs if required by TSL decision matrix
2. Worksites need positive traffic management to ensure all road users travel at the TSL
3. Use cones to form a threshold treatment at the start of the new seal. Minimum of 10 cones at 5m centres
4. Cones on the trafficked side of signs for sites to be left unattended overnight
5. TSLs to be repeated at not more than 400m intervals
6. The T144 X0km/h AHEAD sign is optional

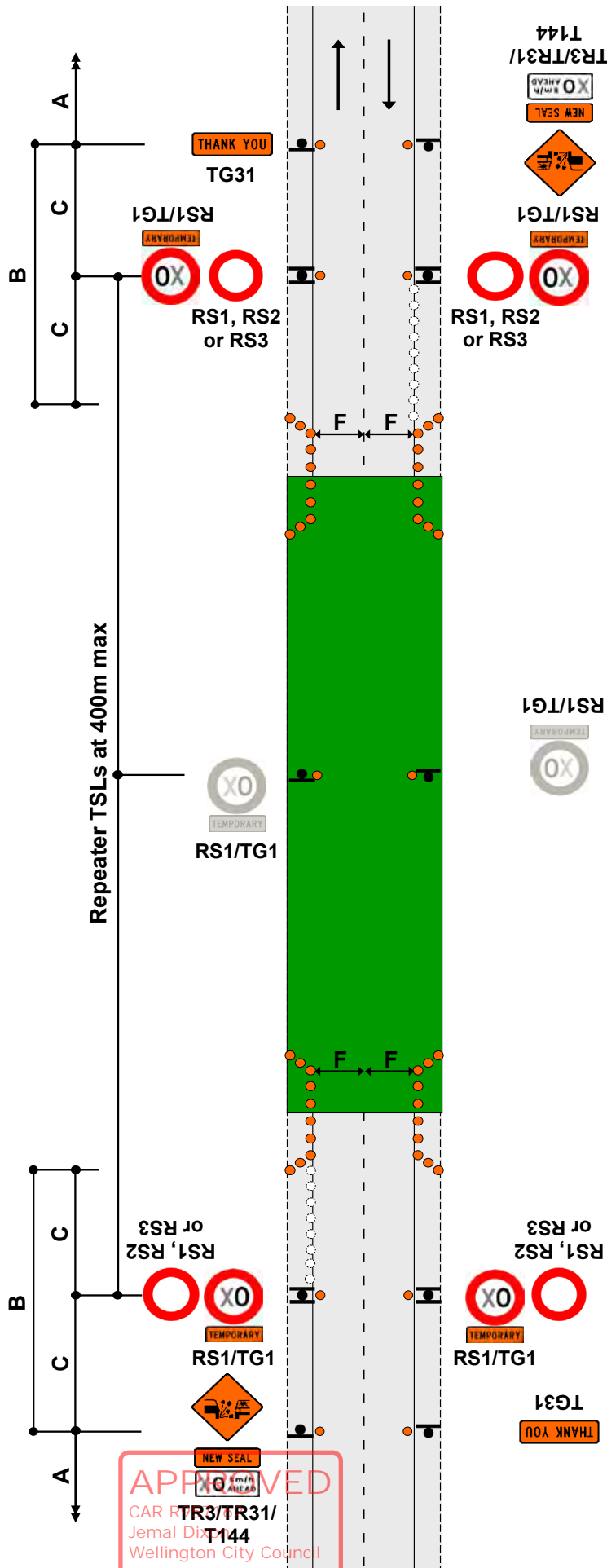





APPROVED  
 CAR R...  
 Jemal Dix...  
 Wellington City Council

07 September 2023

Notes

1. This layout must not be used on an alignment with horizontal curves (corners) or when repairs are carried out on or near horizontal curves. See TMD F2.29
2. On long worksites, use 'Next X km' plates, repeat temporary speed limit signs at not more than 400m intervals
3. Signs for some alternative situations:

TR4		Uneven Surface
TR2		Slippery Surface
TR3		Gravel/Unsealed Surface
TR31		New Seal
TR32		Seal Repairs

4. Cones to be placed on left of carriageway for full length of hazard at 10m centres or at least 3 cones, whichever is the greater
5. Cones on the trafficked side of signs for sites to be left unattended overnight
6. Worksites need positive traffic management to ensure all road users travel at the TSL
7. Use TSLs if required by TSL decision matrix
8. The T144 X0km/h AHEAD sign is optional

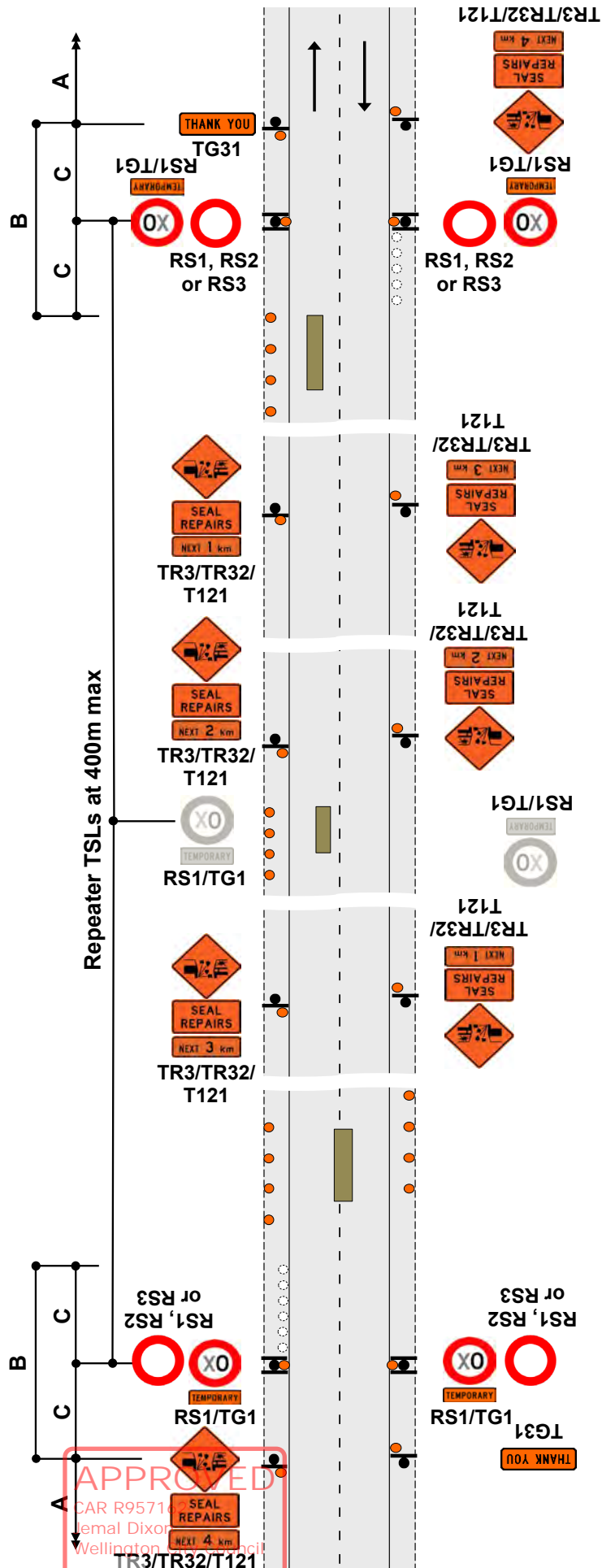

Notes

1. Cones on edge of seal - minimum 3 cones, maximum spacing 10m, next to each repair area
2. Cover any curve advisory speed sign that has a higher speed than the TSL
3. Use TSLs if required by TSL decision matrix
4. The T144 X0km/h AHEAD sign is optional

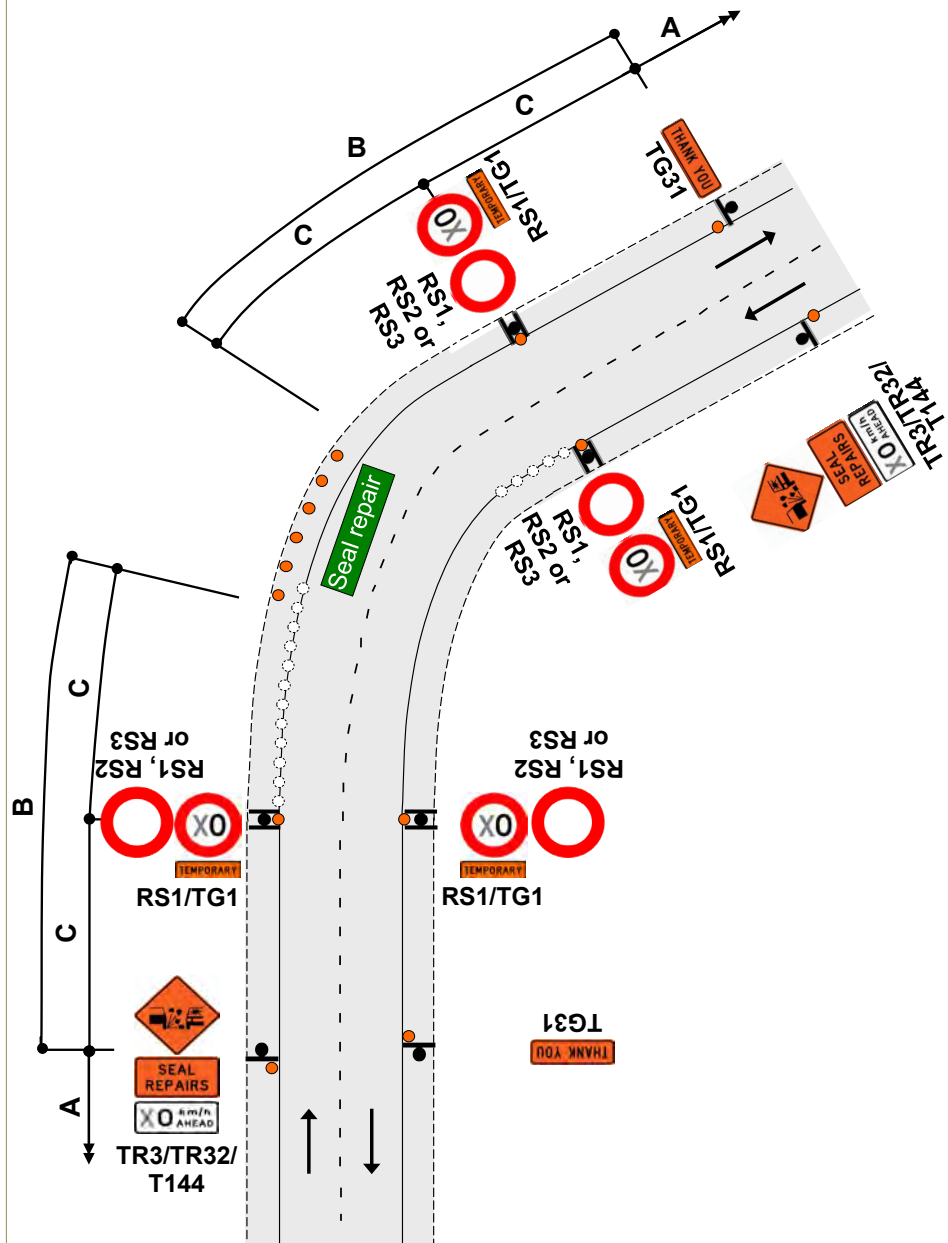

APPROVED

CAR R957162  
Jemal Dixon  
Wellington City Council

*Jemal Dixon*

Section F



Notes

1. Use TSLs if required by TSL decision matrix
2. On roads with a permanent speed limit of 100km/h, cones are required from the TSL to the taper if the speed is reduced by more than 30km/h
3. The T144 X0km/h AHEAD sign is optional

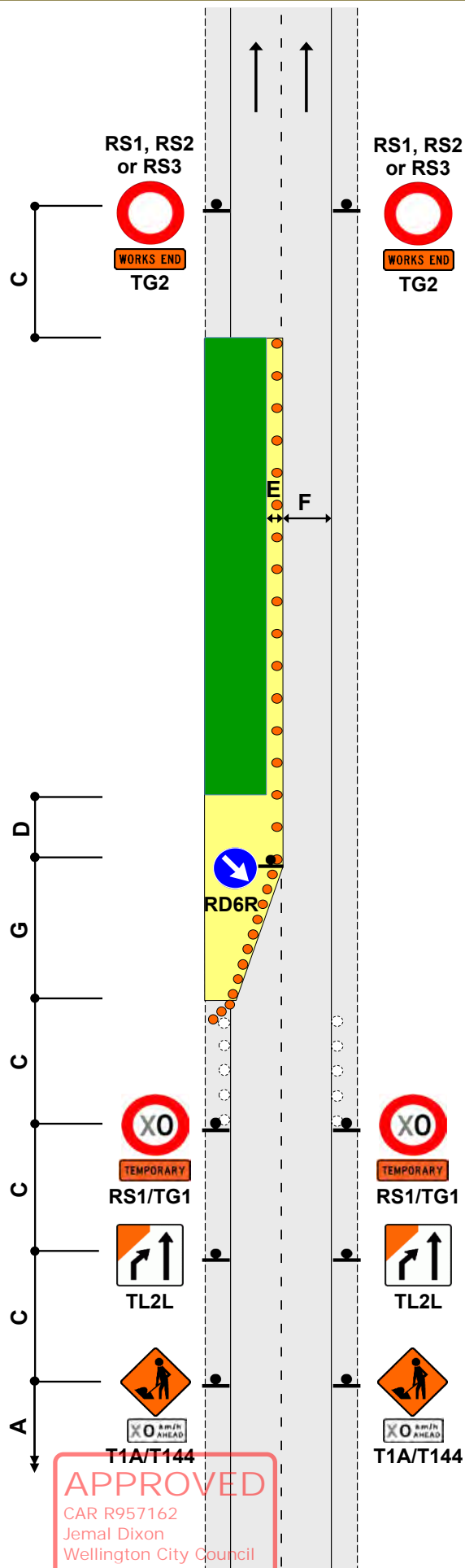

- Notes
1. Use TSLs if required by TSL decision matrix
  2. On roads with a permanent speed limit of 100km/h, cones are required from the TSL to the taper if the speed is reduced by more than 30km/h
  3. The T144 X0km/h AHEAD sign is optional

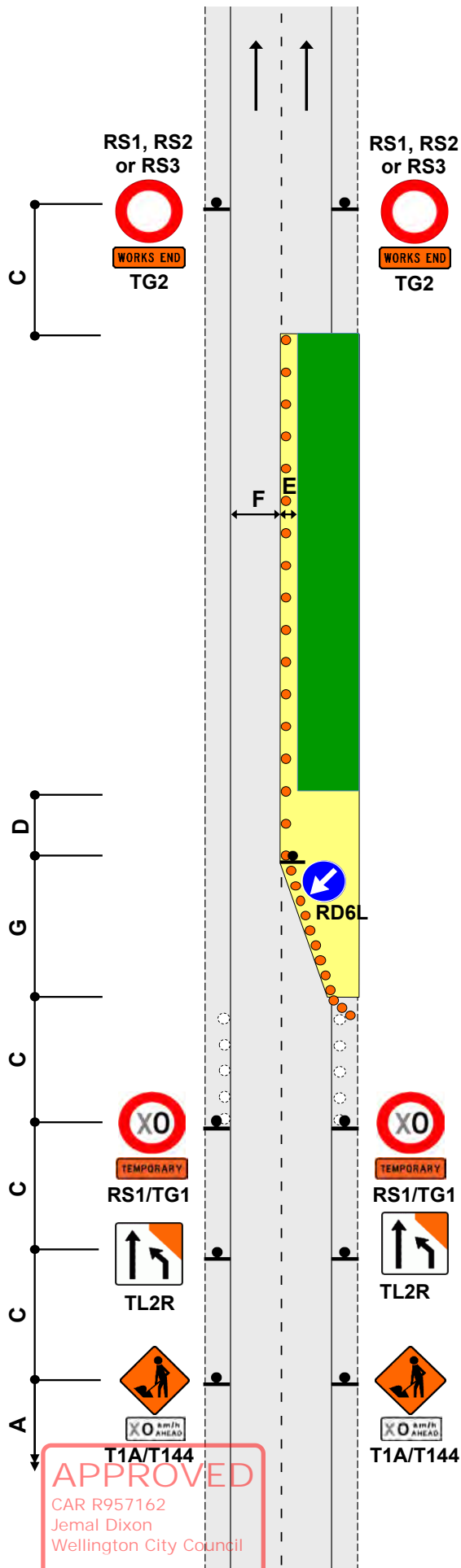

TWO-WAY TWO-LANE ROAD

Work vehicle is more than five (5) metres from the edgeline

Any speed

F4.1  
Level 1

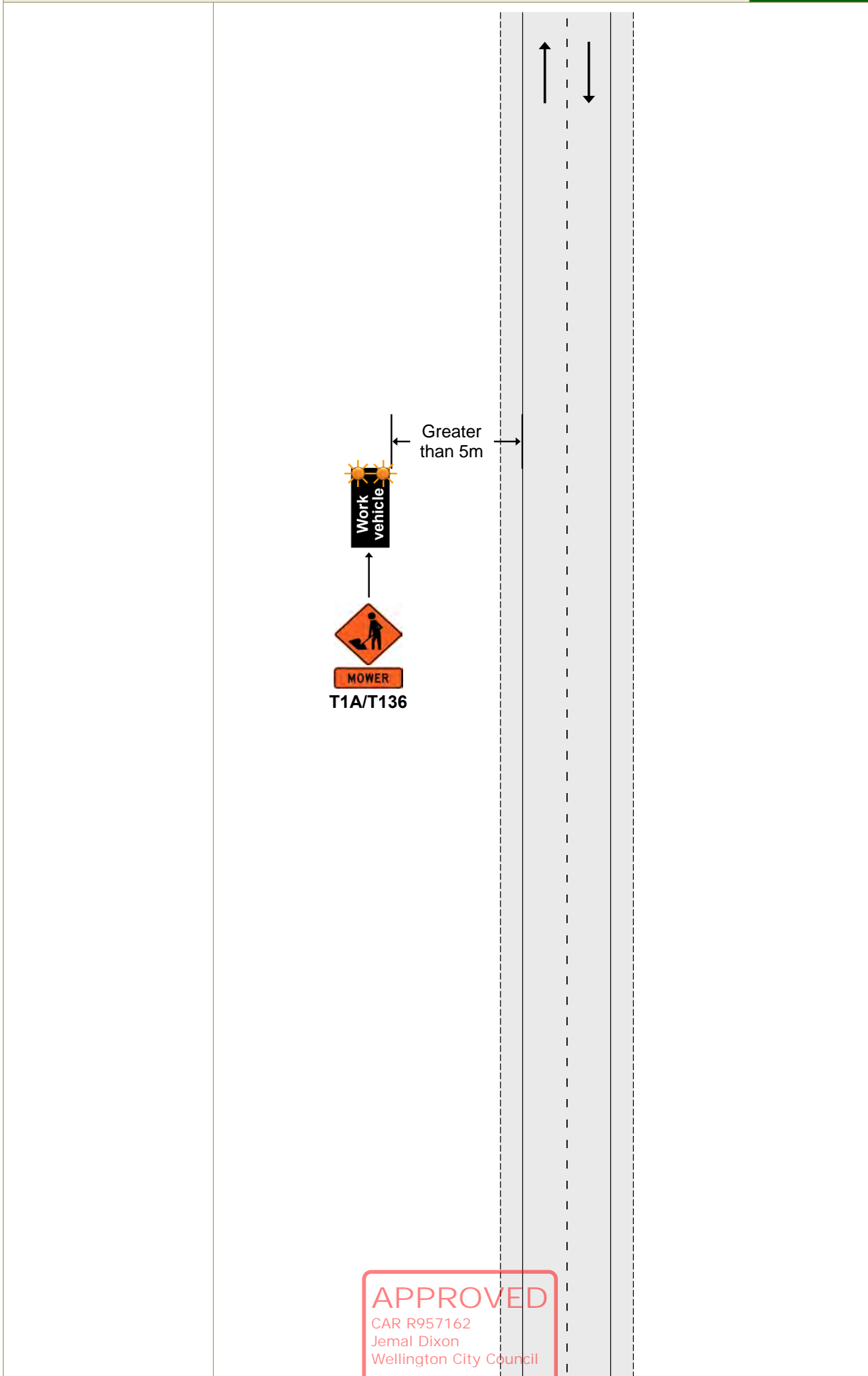

**APPROVED**  
CAR R957162  
Jemal Dixon  
Wellington City Council

Section F

TWO-WAY TWO-LANE ROAD

Work vehicle is within five (5) metres of the edgeline

CSD to work vehicle - not required under 65km/h, required over 65km/h

Notes

- 1. If permanent speed is under 65km/h, rear visibility to the work vehicle is not required
- 2. If permanent speed is over 65km/h, rear visibility to the work vehicle is required
- 3. A tail pilot vehicle equipped with T1A advance warning sign, appropriate supplementary plate and RD6R may replace the static signs if the permanent speed is under 65km/h (see TMD F4.3)

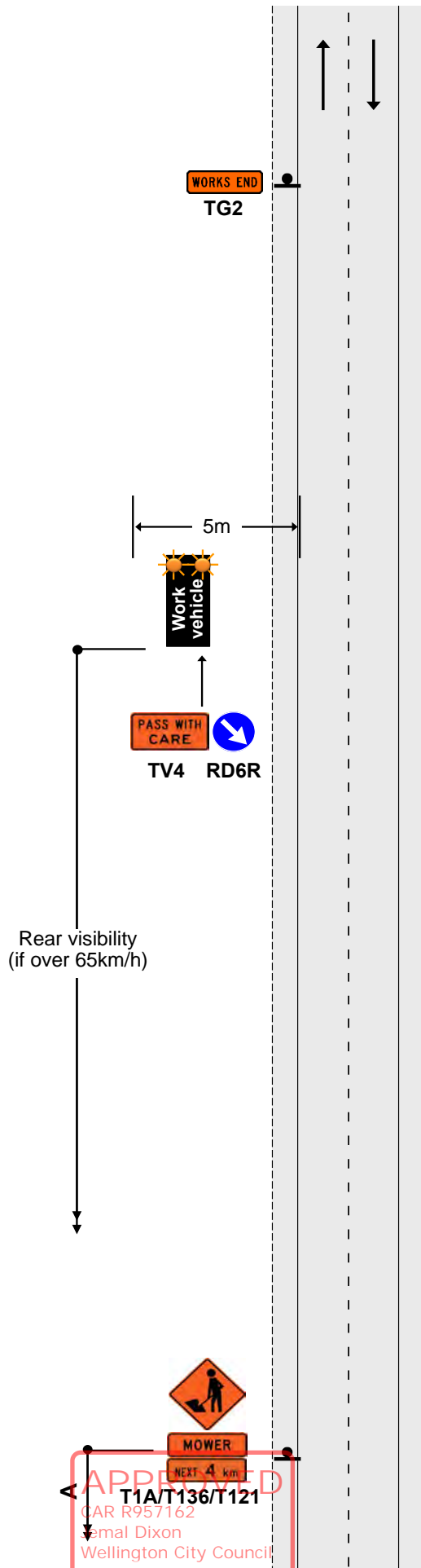

TWO-WAY TWO-LANE ROAD

Work vehicle is within five (5) metres of the edgeline

Speed limit over 65km/h - the rear visibility is less than CSD

Notes

1. This TMD can replace TMD F4.2 when permanent speed is under 65km/h. In these situations, static signs are not required

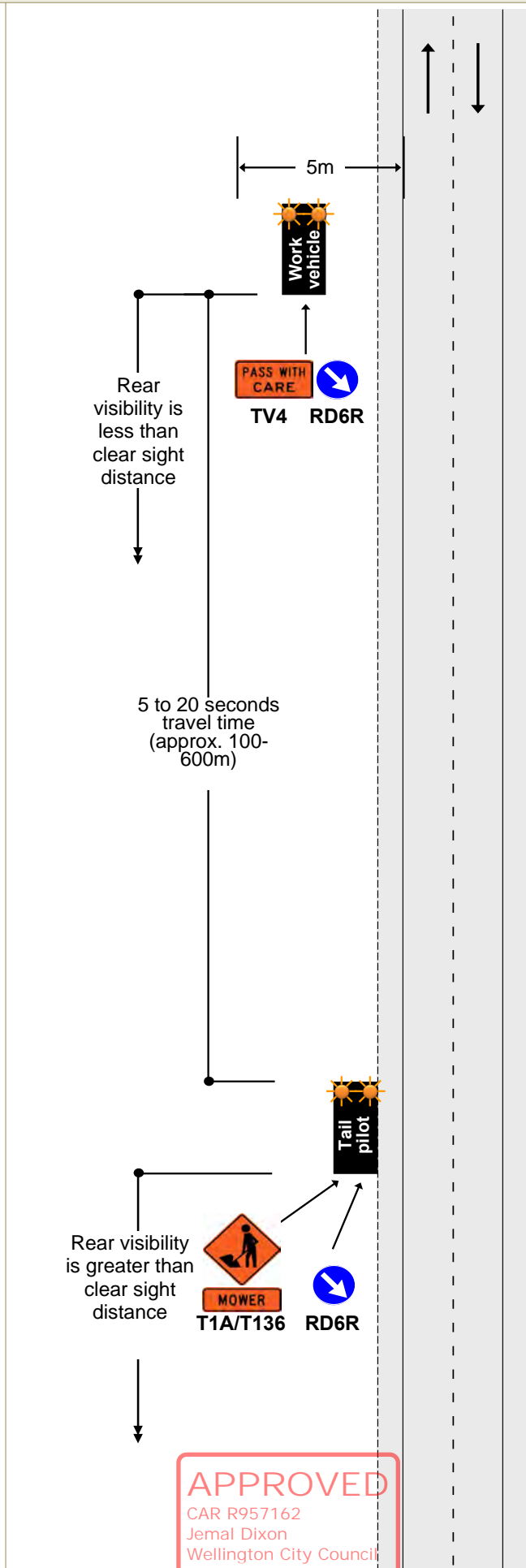

**APPROVED**  
 CAR R957162  
 Jemal Dixon  
 Wellington City Council

TWO-WAY TWO-LANE ROAD  
 Work vehicle is in a lane  
 Permanent speed under 65km/h

F4.4  
 Level 1

- Notes
1. Advance warning sign X may be replaced by tail pilot equipped with T1A advance warning sign and appropriate supplementary plate
  2. In this case, signs marked with Y do not need to be erected
  3. If using static advance warning signs and the operation is on the lane, then static advance warning signs must also be placed on any intersecting roads

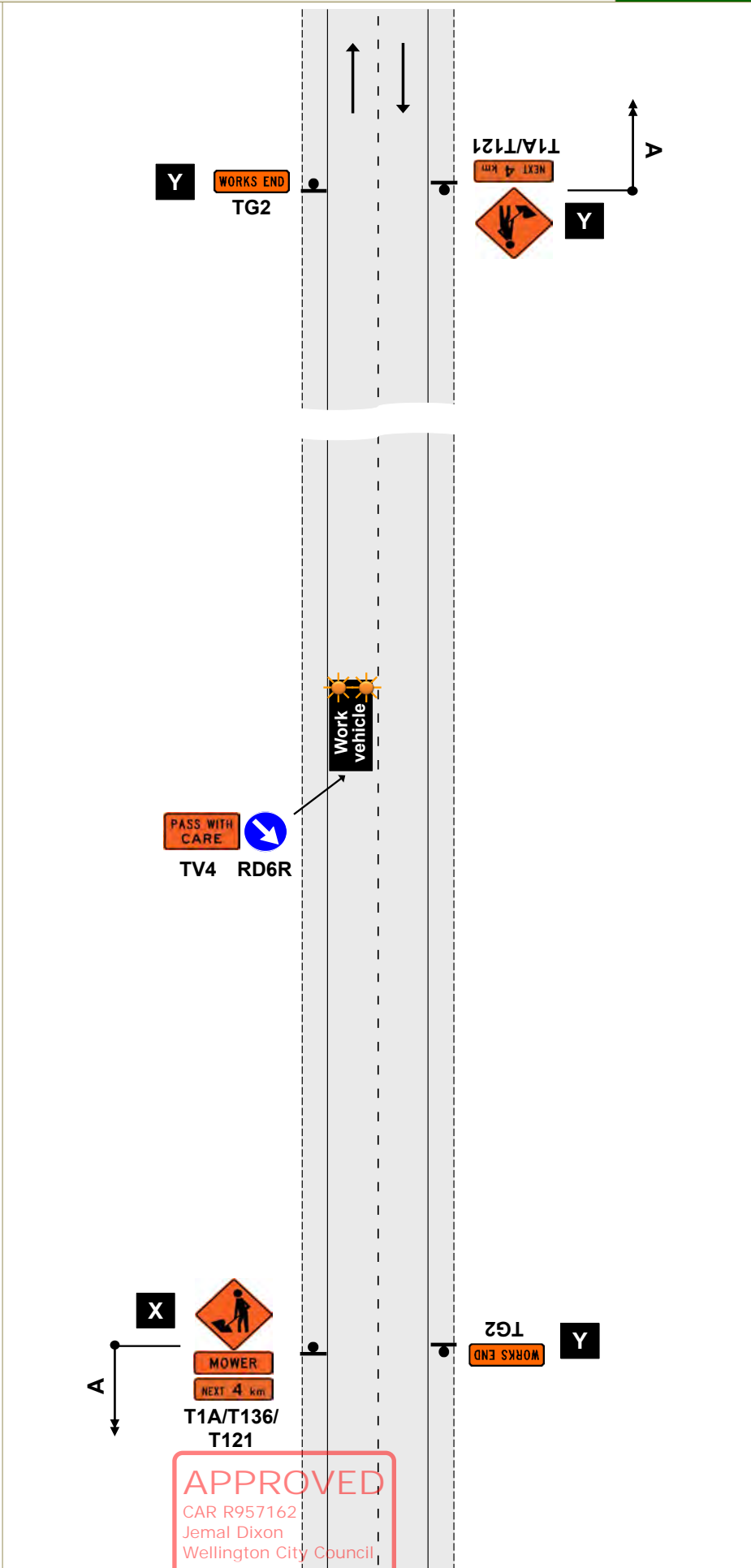

APPROVED  
 CAR R957162  
 Jemal Dixon  
 Wellington City Council

07 September 2023

CYCLE LANE  
Traffic not crossing road centre  
Diverted cycle lane

- Notes
1. Minimum cycle lane width must be:
    - 1m - 50km/h or less
    - 1.5m - 60km/h or more
  2. A minimum cycle lane width of 1.5m is required if the temporary cycle lane is uphill
  3. \*Calculation of taper length for lateral shift of less than 3.5m is:  

$$\frac{W \times G}{3.5}$$

W = Width of lateral shift  
 G = Taper length in metres from the level 1 layout distance table
  4. Use TSLs if required by TSL decision matrix
  5. The T144 X0km/h AHEAD sign is optional

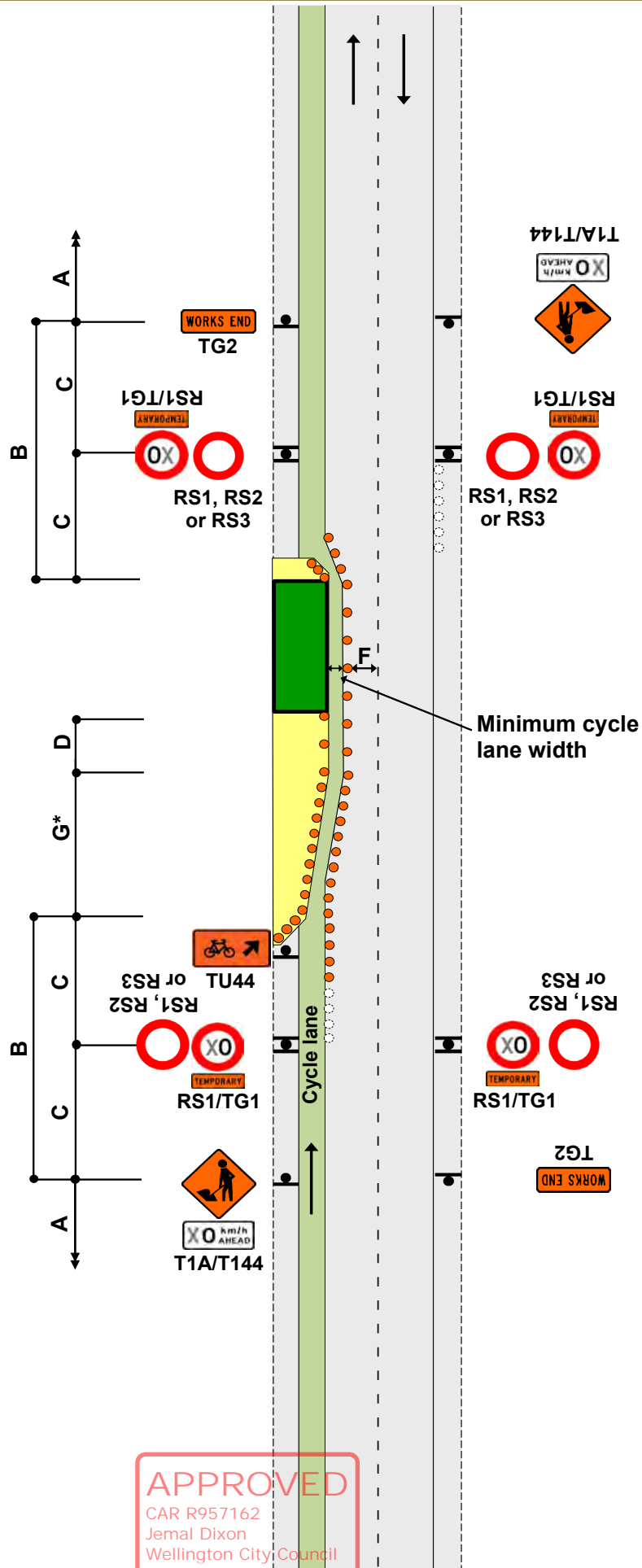

**APPROVED**  
 CAR R957162  
 Jemal Dixon  
 Wellington City Council

CYCLE LANE

Traffic crossing road centre

Diverted cycle lane - coned lane control

F2.9

Level 1

Notes

1. Minimum cycle lane width must be:
  - 1m - 50km/h or less
  - 1.5m - 60km/h or more
2. A minimum cycle lane width of 1.5m is required if the temporary cycle lane is uphill
3. \*Calculation of taper length for lateral shift of less than 3.5m is:  

$$\frac{W \times G}{3.5}$$

W = Width of lateral shift  
 G = Taper length in metres from the level 1 layout distance table
4. To allow heavy vehicles to manoeuvre, cones in the channel must be offset by at least 10m where the direction changes. Refer C8.2.12
5. Use TSLs if required by TSL decision matrix
6. The T144 X0km/h AHEAD sign is optional

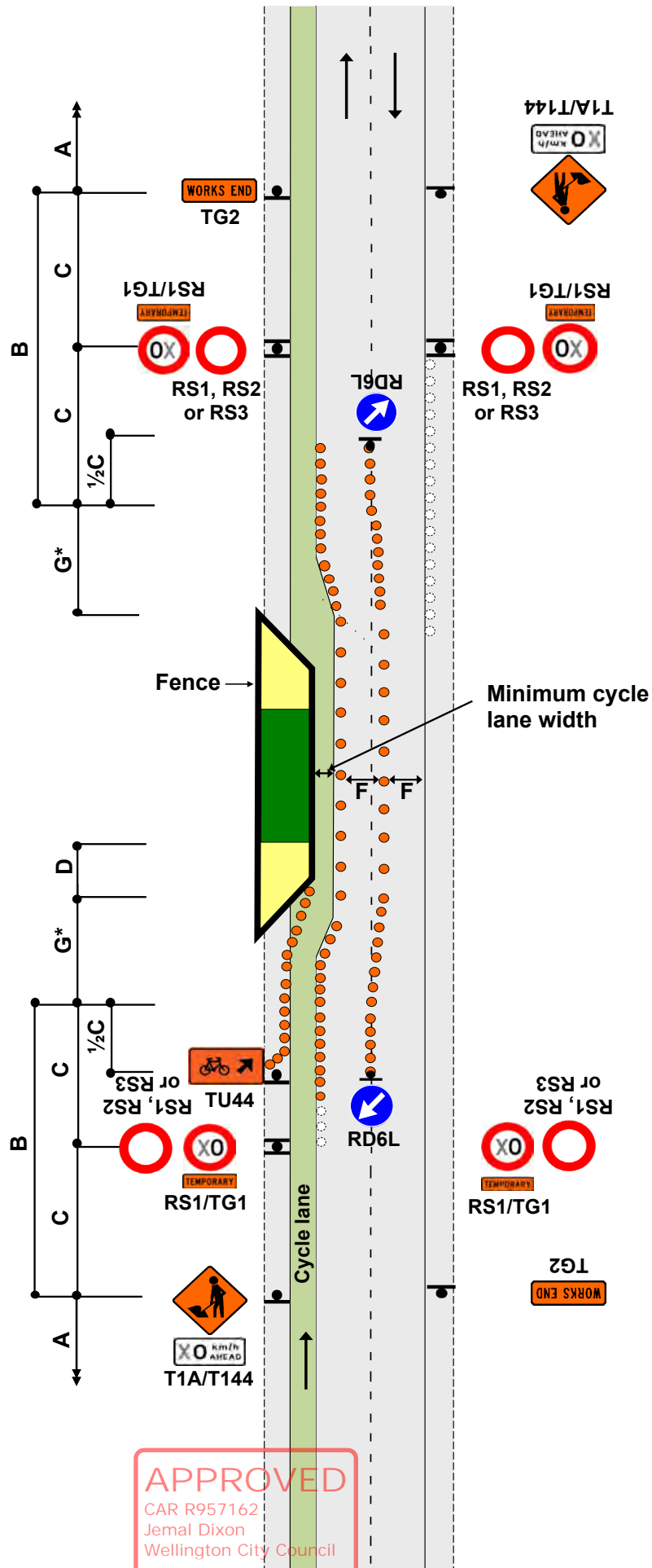

APPROVED

CAR R957162  
 Jemal Dixon  
 Wellington City Council

07 September 2023



INSPECTION ACTIVITIES AND NON-INVASIVE WORKS  
 On shoulder and on the live lane  
 This TMD may also be applied on level LV roads

F4.10  
 Level 1

- Notes
1. Inspectors must move from live lanes to avoid traffic. They must not expect traffic to drive slowly or drive around them
  2. On level LV and level 1 roads, a person completing an inspection or non-invasive works cannot be on a live lane for more than 5 minutes
  3. Unless otherwise approved by the RCA, all inspections on the live lane of level 1 roads require a spotter. The RCA may provide a list of roads, times and/or activities suitable for inspection by a single inspector
  4. There must be CSD to the inspector when on the live lane. If this cannot be achieved, a spotter must be placed in a position where CSD can be attained and verbal instructions be given to the inspector. If this is not possible, a static or mobile operation is required.
  5. A spotter is not required for inspections and non-invasive works on level LV roads or working off the live lane of a level 1 road
  6. Where an unaccompanied inspector is not able to maintain adequate attention (eg due to work tasks or poor visibility), a spotter will be required or another type of traffic management operation used
  7. For inspection activities that are carried out by a TC on level LV and level 1 roads the STMS must be immediately contactable but does not have to be within 30 minutes travel time of the worksite
  8. An unaccompanied inspector may walk across a level LV or level 1 road
  9. A vehicle is not required on a level LV or level 1 road with a permanent speed of less than 65km/h if the inspector remains on a footpath
  10. On roads with a permanent speed of less than 65km/h an amber flashing beacon is not required on the vehicle if the inspector or non-invasive works is on an unsealed shoulder (or further away from the carriageway - including a footpath)

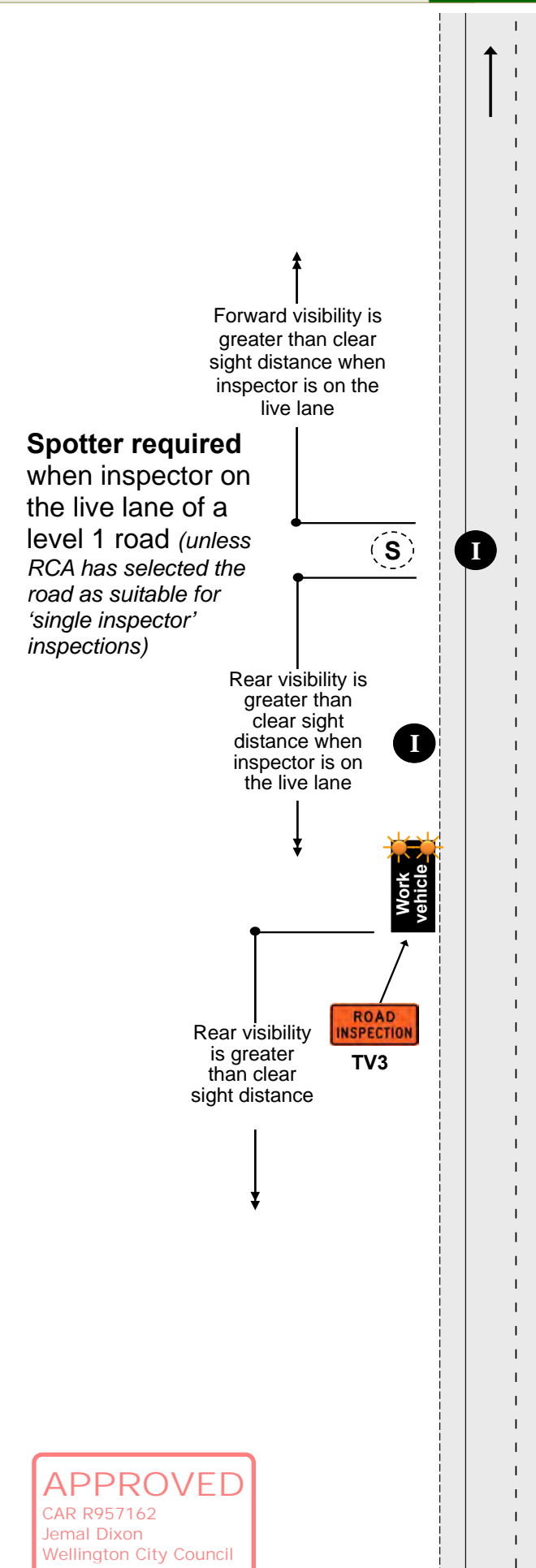

**APPROVED**  
 CAR R957162  
 Jemal Dixon  
 Wellington City Council

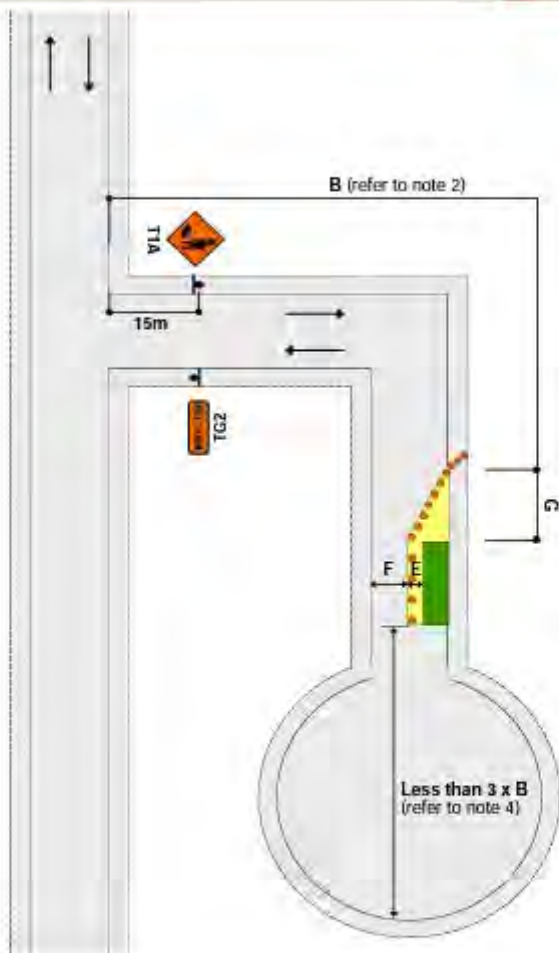

Notes

1. T1A sign to be placed at least 15m from the intersection
2. Where less than  $B$ , T1A/T135 and TG2 signs required on main road
3. Working space to be less than 100m
4. Signage is not required past the worksite where there is less than  $3 \times B$  from the end of the working space to the end of the road

APPROVED

CAR R957162  
Jemal Dixon  
Wellington City Council

**TWO-WAY TWO-LANE ROAD - Intersection or roundabout**

Major obstruction close to intersection

Allows shorter sign spacings and MTC operation

**J2.19a**

Level 1

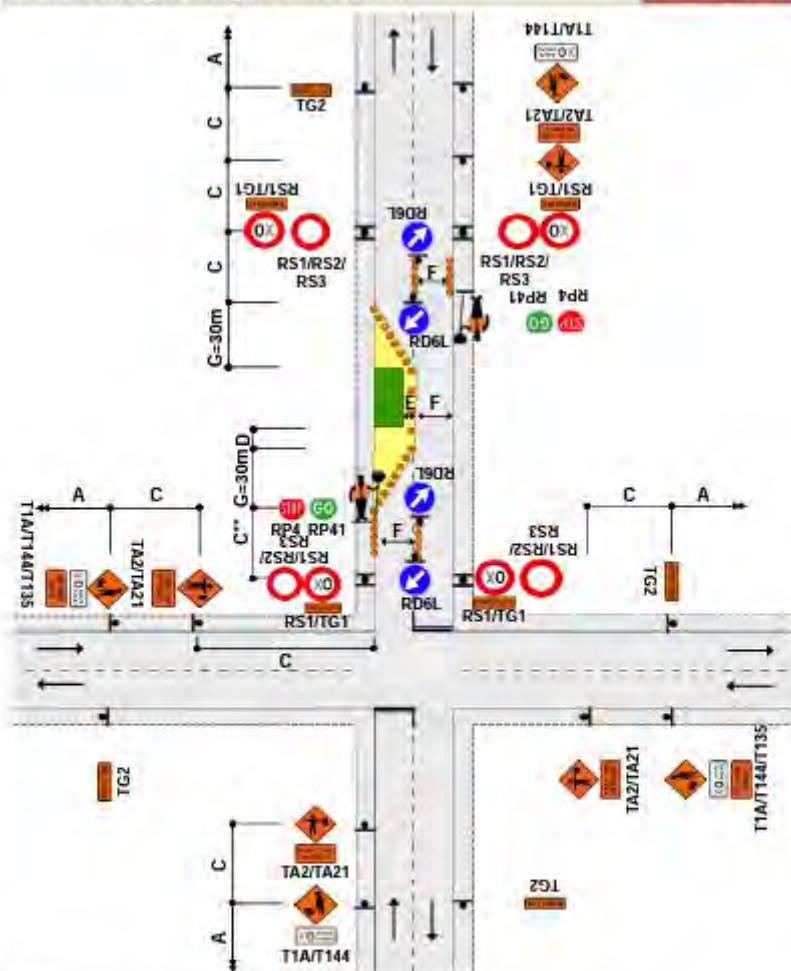

**Notes**

1. Sign spacing of TSL at the intersection can be reduced as per the table shown
2. This diagram may be used at a T intersection by removing any one of the roads
3. MTC at intersection to be in charge of MTC operation
4. Use TSLs as required by TSL decision matrix
5. The T144 30km/h AHEAD sign is optional

C**	DISTANCE		
	Speed (PSL)	Intersection to TSL	TSL to taper
<60km/h	5m	19m	30m
60-70km/h	19m	25m	40m
>70km/h	5m	40m	55m

APPROVED  
 Decision matrix  
 Jemal Dixon  
 City Council

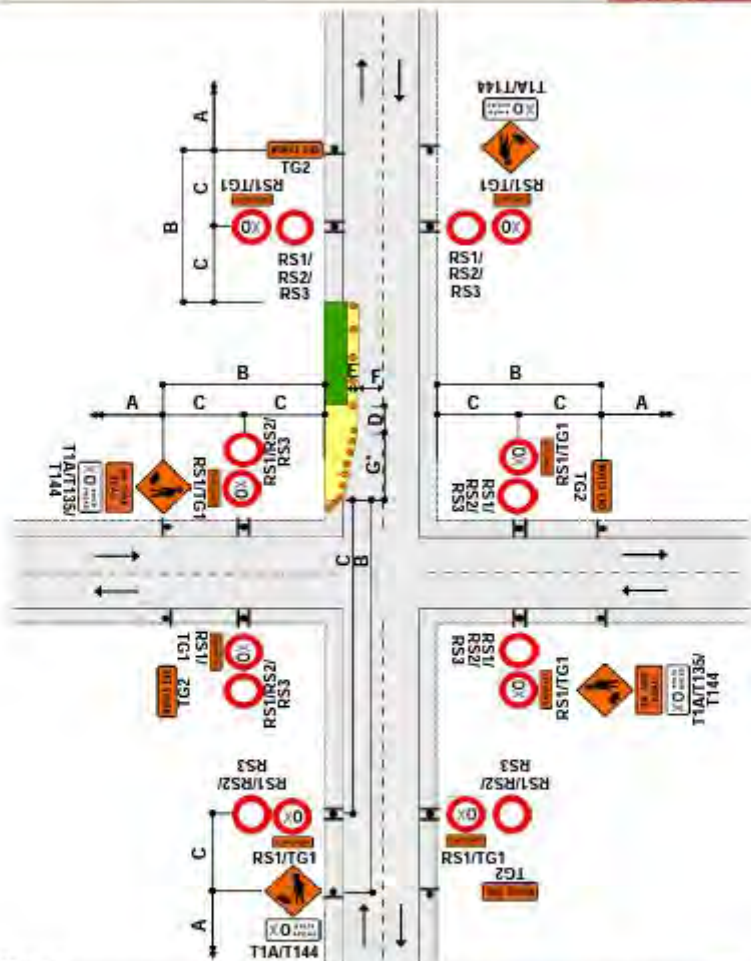

Notes

1. This diagram may be used at a T intersection by removing any one of the roads.
2. Taper length may be reduced by adding a RD6R sign.
3. \*Calculation of taper length for lateral shift of less than 3.5m is:

$$\frac{W \times G}{3.5}$$

W = Width of Shoulder G = Taper length in metres from the level 1 layout distance table

4. Use TSLs if required by TSL decision matrix.
5. The T144 X0km/h AHEAD sign is optional.



APPROVED  
CAR R957162  
Wellington City Council

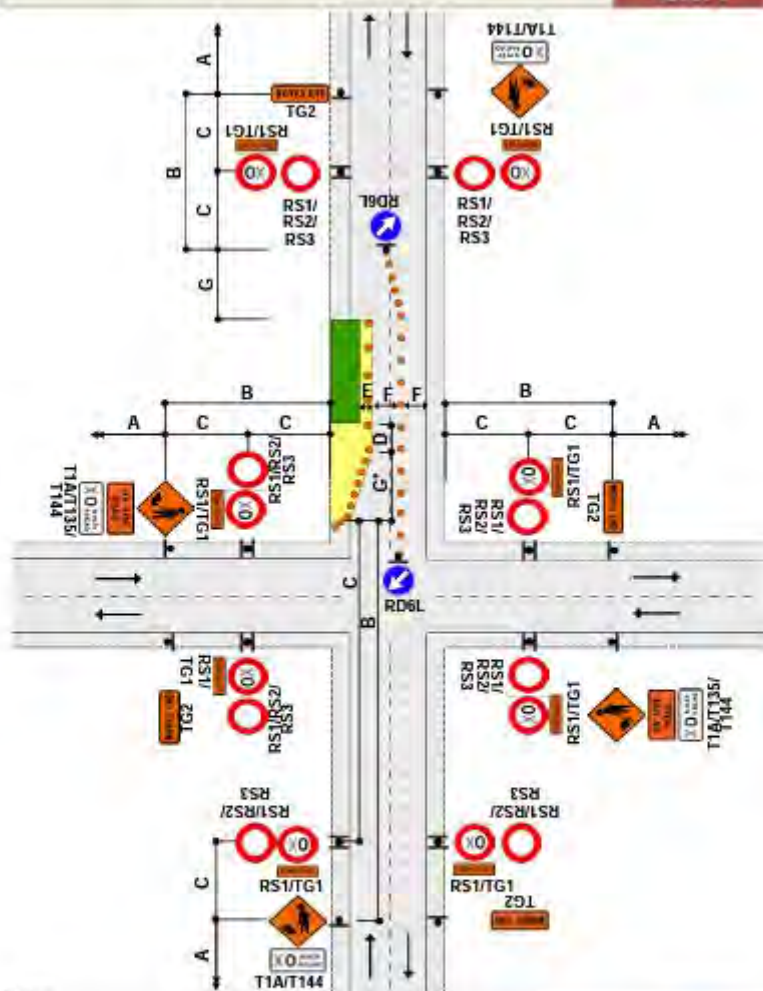

Notes

1. This diagram may be used at a T intersection by removing any one of the roads
2. Taper length may be reduced by adding a RD6R sign
3. \*Calculation of taper length for lateral shift of less than 3.5m is:

$$\frac{W \times G}{3.5}$$

4. W = Width of Shoulder G = Taper length in metres from the level 1 layout distance table

4. Use TSLs if required by TSL decision matrix
5. The T144 X0km/h AHEAD sign is optional



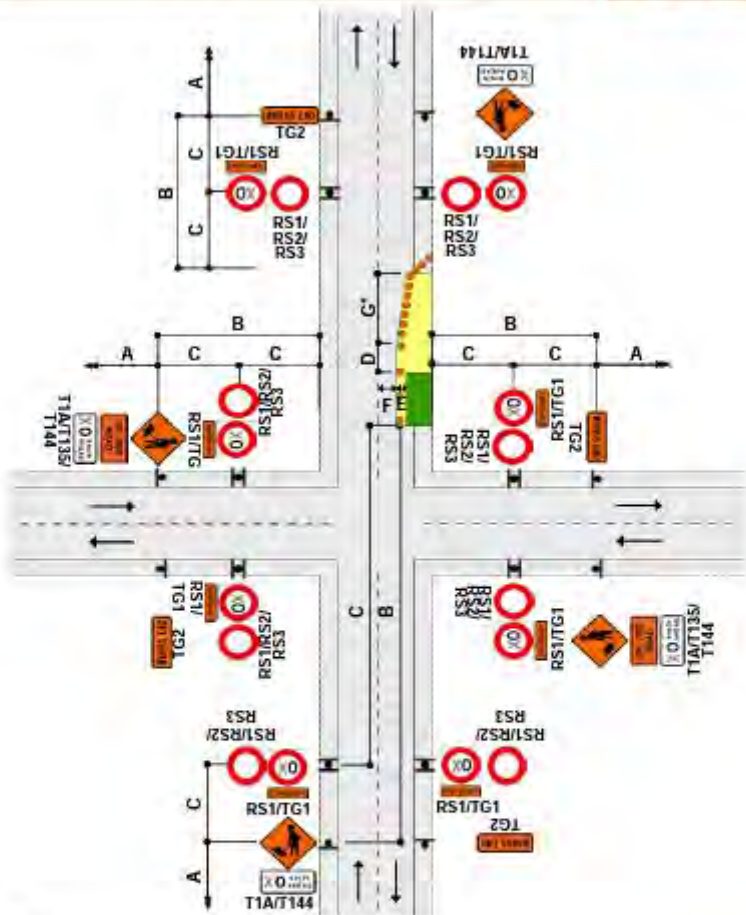

Notes

1. This diagram may be used at a T intersection by removing any one of the roads
2. Taper length may be reduced by adding a RD6R sign
3. \*Calculation of taper length for lateral shift of less than 3.5m is:

$$\frac{W \times G}{3.5}$$

W = Width of Shoulder G = Taper length in metres from the level 1 layout distance table

4. Use TSLs if required by TSL decision matrix
5. The T144 X0km/h AHEAD sign is optional



APPROVED  
 CAR R957162  
 Jemal Dixon  
 Wellington City Council

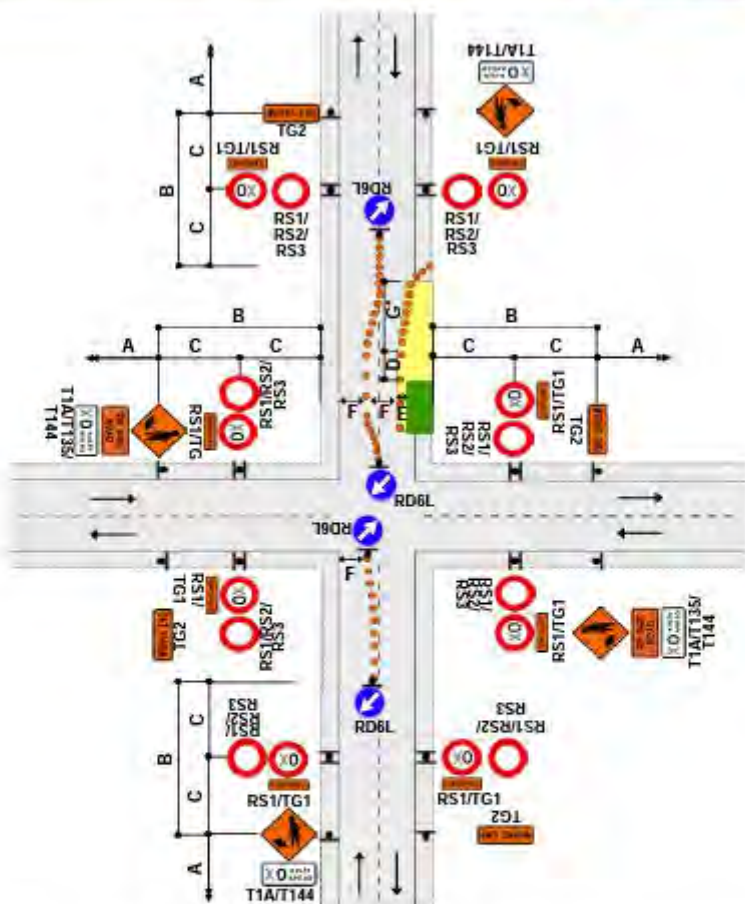

Notes

1. This diagram may be used at a T intersection by removing any one of the roads
2. \*Calculation of taper length for lateral shift of less than 3.5m is:

$$\frac{W \times G}{3.5}$$

3.5

W = Width of lane G = Taper length in metres from the level 1 layout/distance table

3. Install shifting taper to move road users into the new alignment
4. Use TSLs if required by TSL decision matrix
5. The T144 X0km/h AHEAD sign is optional



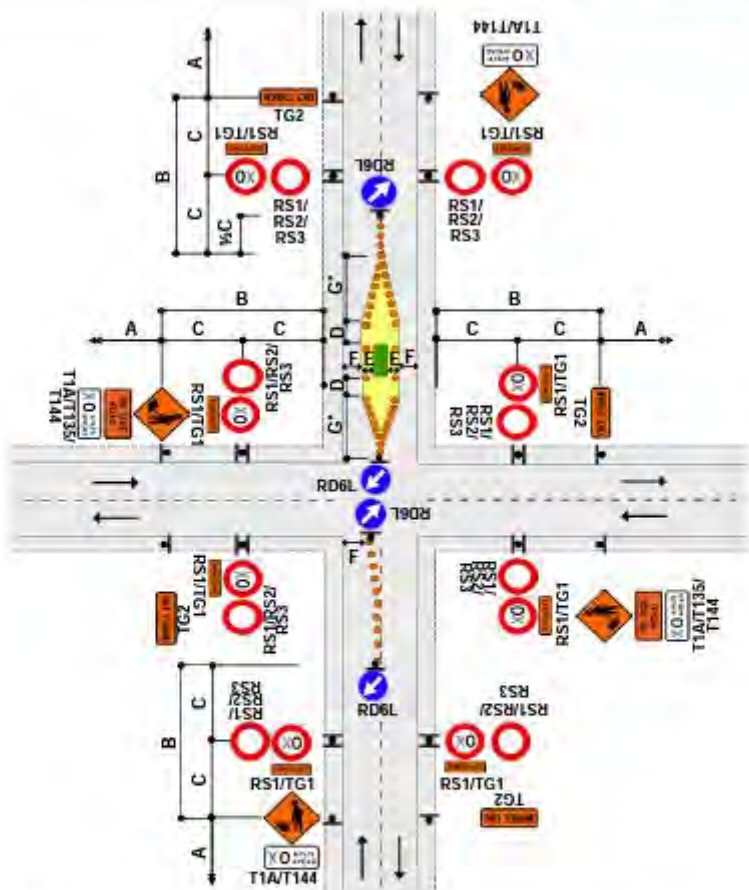

Notes

1. This diagram may be used at a T intersection by removing any one of the roads

2. \*Calculation of taper length for lateral shift of less than 3.5m is:

$$\frac{W \times G}{3.5}$$

W = Width of lane G = Taper length in metres from the level 1 layout distance table

3. Install shifting taper to move road users into the new alignment.

4. Use TSLs if required by TSL decision matrix.

5. The T144 X0km/h AHEAD sign is optional.

APPROVED

CAR R957162  
Jemal Dixon  
Wellington City Council



**TWO-WAY TWO-LANE ROAD**  
**Single-lane alternating flow**  
**Portable e-STOP**

**ATMS02**  
**Level 1**

**Notes**

- Provide details of make and model of portable traffic signals in the TMP
- Use PN11 no stopping signs, if necessary as per the approved TMP
- Install temporary RP61/RP62 signs
 

STOP  
ON RED  
SIGNAL

STOP  
HERE  
ON RED  
SIGNAL
- Minimum 5 cones in cone threshold.
- Extend or place extra advance warning signs towards on-coming traffic beyond any expected traffic queues
- CONTINGENCY PLAN:  
 F2.14 to be implemented should issues arise with e-STOP/ adverse weather conditions or where stop go is unsuitable.  
 ex; Short term stoppages is defined as “stopping traffic for a short period of time within a static site, at inconsistent intervals to assist with the entry/exit of vehicles or small tasks required to be undertaken in the live lane”.
- In circumstances where for safety reasons, the use of stop/go operations is deemed more appropriate, a site specific safe work method statement must be prepared.
- The T144 30km/h AHEAD sign is optional on roads under 65km/h
- e-STOP can only be used on an attended site. e-STOPS must be manned at all times.

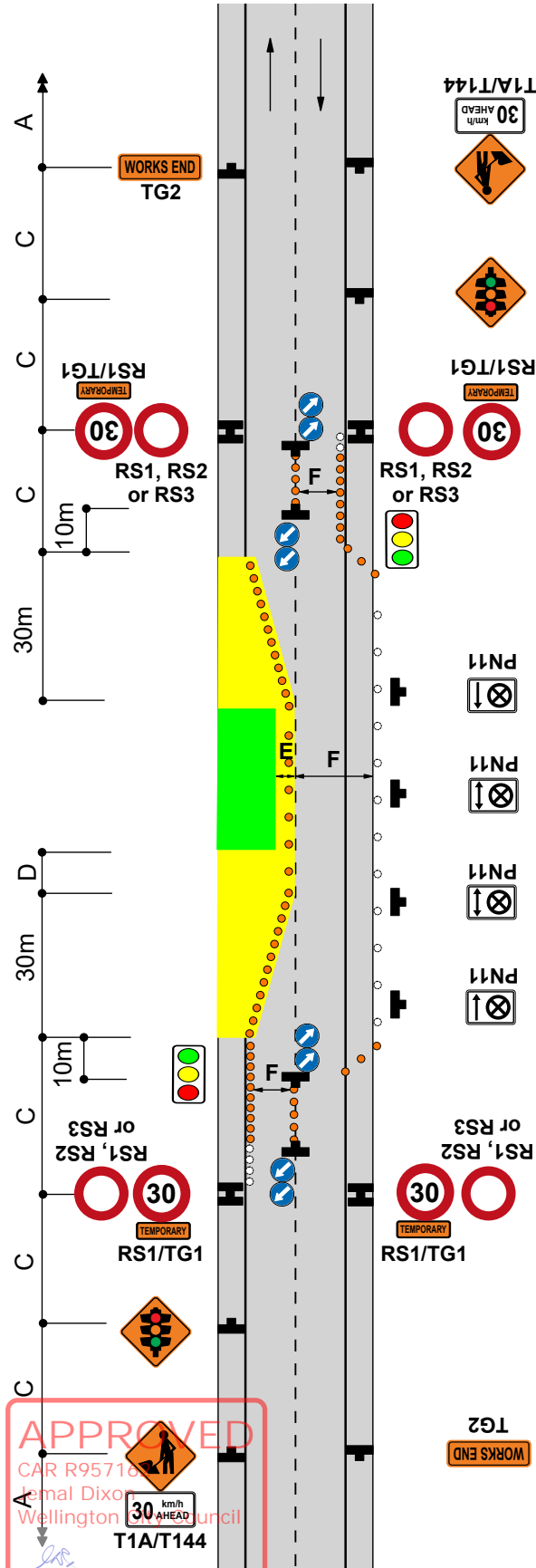

APPROVED

CAR R95716  
 Jemal Dixon  
 Wellington Council

30 km/h  
AHEAD  
T1A/T144

**Static operations**

**CYCLE LANE**  
**Cycle lane closed**  
**Portable e-STOP**

**ATMS03**  
**Level 1**

**Notes**

1. Merge of cycle lane with live lane must be delineated with cones at 1.0m centres for at least 10m
2. The T144 30km/h AHEAD sign is optional on roads under 65km/h
3. Signs and layout shown in the box at the bottom of the diagram is to be repeated on each approach that requires cycle lane signage. ATMS01 or ATMS02 to be used on all non cycle lane approaches.
3. Provide details of make and model of portable traffic signals in the TMP
4. Use PN11 no stopping signs, if necessary as per the approved TMP

5. Install temporary RP61/RP62 signs.



7. Extend or place extra advance warning signs towards on-coming traffic beyond any expected traffic queues.

8. CONTINGENCY PLAN:  
 F2.14 or F2.22 to be implemented should issues arise with e-STOP/ adverse weather conditions or where stop go is unsuitable.  
 ex; Short term stoppages is defined as "stopping traffic for a short period of time within a static site, at inconsistent intervals to assist with the entry/exit of vehicles or small tasks required to be undertaken in the live lane".

9. In circumstances where for safety reasons, the use of stop/go operations is deemed more appropriate, a site specific safe work method statement must be prepared.

10. e-STOP can only be used on an attended site. e-STOPS must be manned at all times.

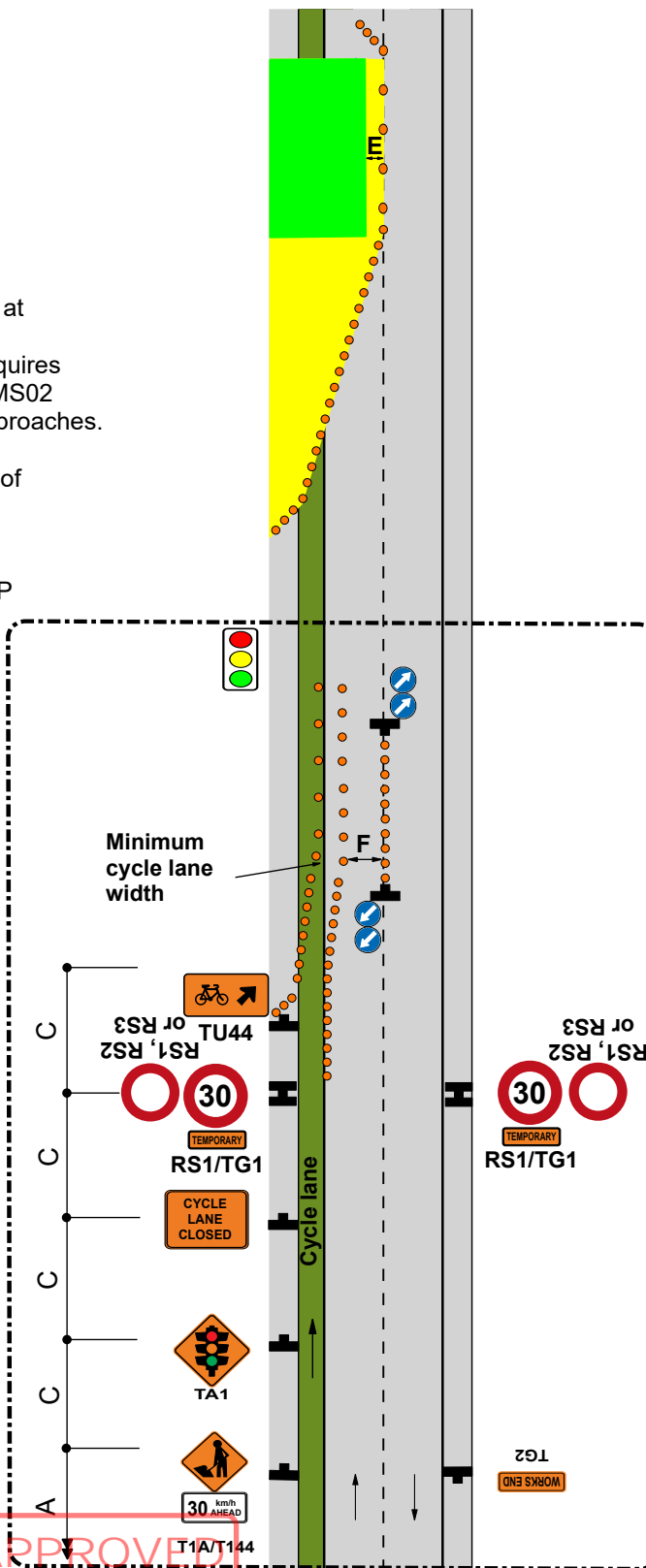

**APPROVED**

CAR R957162  
 Jemal Dixon  
 Wellington City Council

07 September 2023

Signs and layout to be repeated on each cycle lane approach Follow ATMS01 & ATMS02 for non cycle lane approaches.

**Static operations**

**TWO-WAY TWO-LANE ROAD - Intersection or roundabout  
Closure at an intersection  
Portable e-STOP - with MTC on side roads**

**ATMS04  
Level 1**

**Notes**

1. This plan can be used at a 3 way intersection by removing one of the approaches. If you require a temporary traffic light/MTC set up, which is greater than a four way, you will require a site specific TMP.

2. Signs and layout shown in the box at the bottom of the diagram is to be repeated on each approach.

3. Provide details of make and model of portable traffic signals in the TMP

4. Use PN11 no stopping signs, if necessary as per the approved TMP

5. Install temporary RP61/RP62 signs



6. Minimum 5 cones in cone threshold.

7. Extend or place extra advance warning signs towards on-coming traffic beyond any expected traffic queues

8. CONTINGENCY PLAN:  
F2.22 to be implemented should issues arise with e-STOP/ adverse weather conditions or where stop go is unsuitable. ex; Short term stoppages is defined as "stopping traffic for a short period of time within a static site, at inconsistent intervals to assist with the entry/exit of vehicles or small tasks required to be undertaken in the live lane".

9. In circumstances where for safety reasons, the use of stop/go operations is deemed more appropriate, a site specific safe work method statement must be prepared.

10. The T144 30km/h AHEAD sign is optional on roads under 65km/h  
11. e-STOP can only be used on an attended site. e-STOPS must be manned at all times.

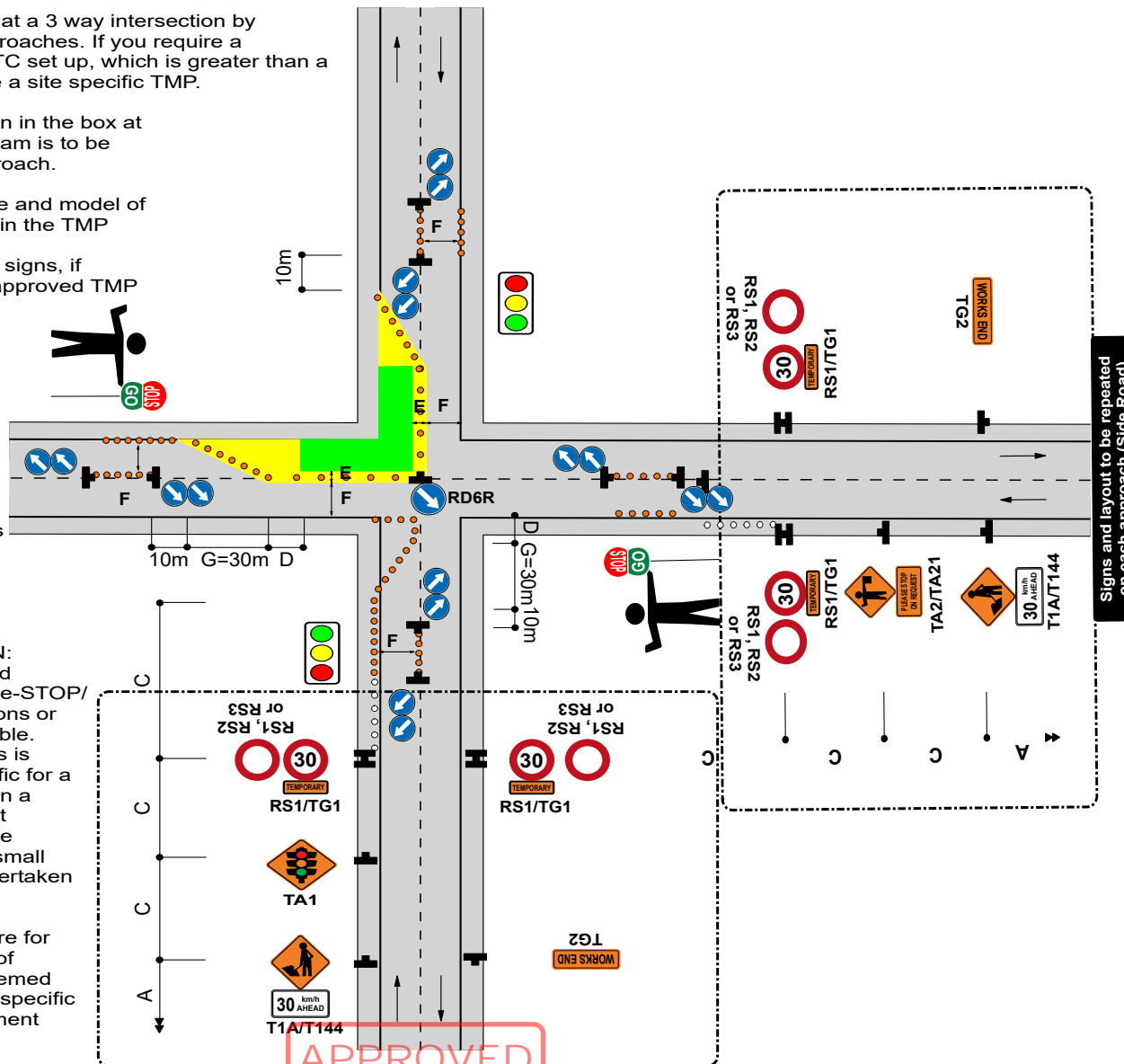

**APPROVED**  
Signs and layout to be repeated on each approach (Main Road)  
Jemal Dixon  
Wellington City Council

07 September 2023

Methodology:  
**PEDESTRIAN PROVISION**

**ROAD LEVEL:  
ALL**

Detail:  
**FOOTPATH CLOSED - PEDESTRIANS ESCORTED**

**SPEED LIMIT:  
ALL**

Restrictions:

# ATMS05

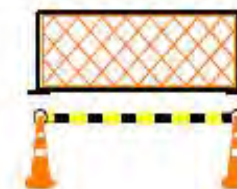

STMS to consider if additional safety measures are appropriate to protect hazards / guide pedestrians past the site e.g. safety fencing / cone bars. This is particularly important around excavations. In some instances requirements may change between attended and unattended sites.

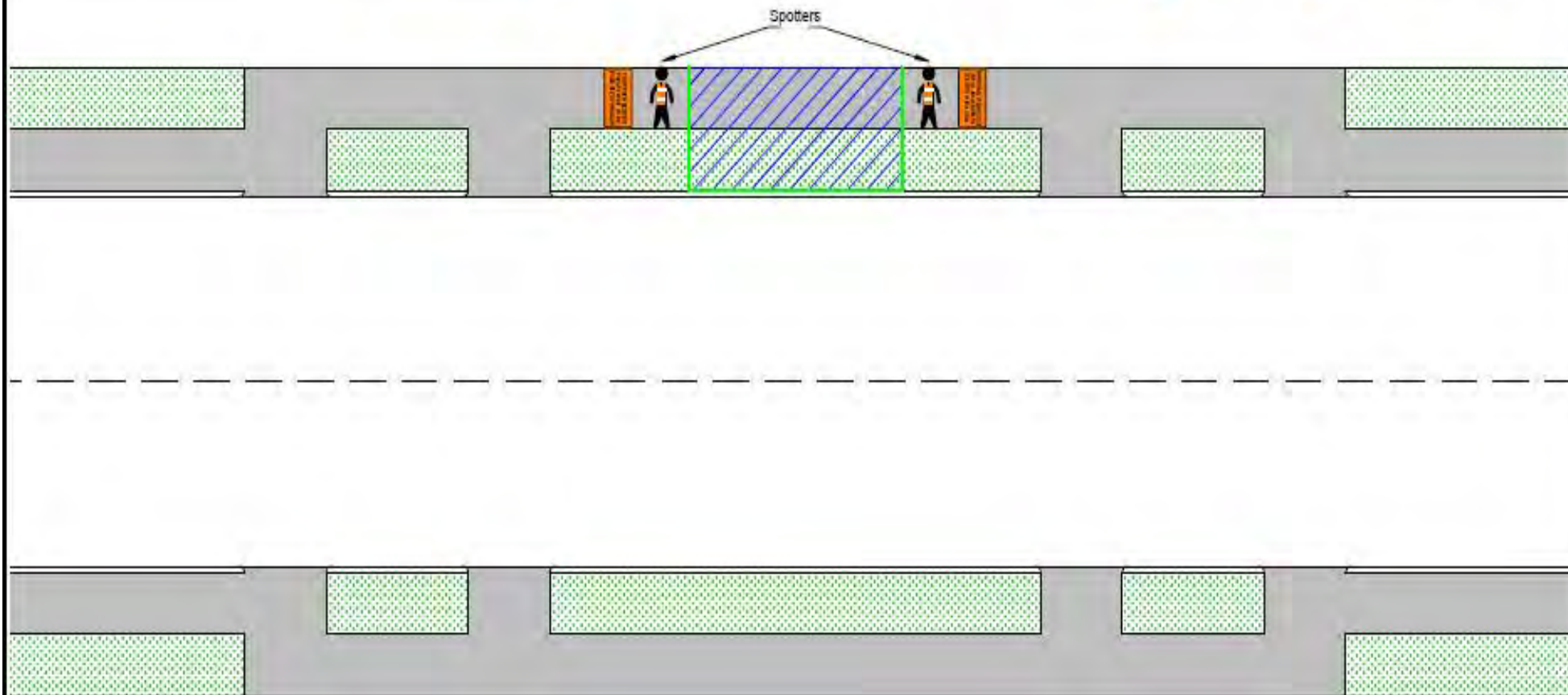

**Notes:**

- One spotter can be used over short distances where they can suitably control pedestrians through the working space i.e. 20m.
- This plan can ONLY be used during attended times.

**APPROVED**  
CAR R957162  
Jemal Dixon  
Wellington City Council  
  
07 September 2023

**FOOTPATH CLOSED  
PLEASE WAIT TO BE  
ESCORTED THROUGH**

Mobile operations

**ONE-WAY TWO-LANE DIVIDED OR TWO-LANE ROAD**  
**Part or all of a lane occupied**  
**Semi-static closure - work for up to 1 hour**

**ATMS06**  
**Level 1**

Notes

1. Only use this TMD when activity can be completed within 1 hour (excluding set up and removal of worksite)
2. The T1A advance warning signs may be replaced by a tail pilot vehicle with a T1A sign, appropriate supplementary plate and a RD6R/L
3. If shadow vehicle is fitted with a TMA, the longitudinal safety zone (D) is not required
4. If using static advance warning signs and the operation is on the lane, then static advance warning signs must also be placed on any intersecting roads.
5. This site can be used on the opposite (left) lane also.

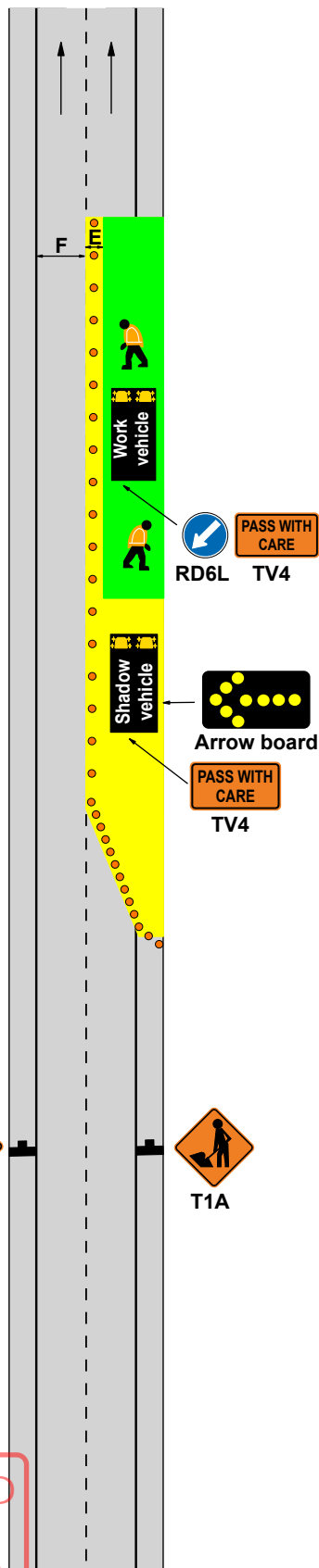
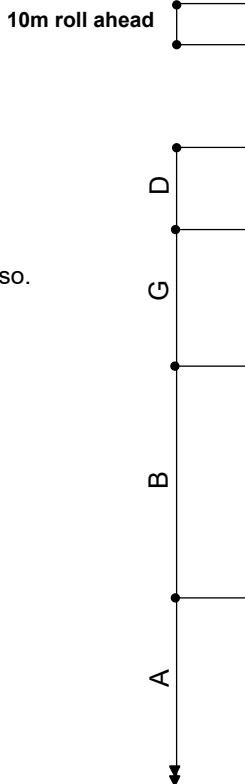

**APPROVED**

CAR R957162  
 Jemal Dixon  
 Wellington City Council

07 September 2023

Mobile operations

**INSPECTION ACTIVITIES AND NON-INVASIVE WORKS**

**Inspection Activity - Centre Of Road**

This TMD may also be applied on level LV roads

**ATMS07**

**Level 1**

**Notes**

1. Inspectors must move from live lanes to avoid traffic. They must not expect traffic to drive slowly or drive around them
2. On level LV and level 1 roads, a person completing an inspection or non-invasive works cannot be on a live lane for more than 5 minutes
3. Unless otherwise approved by the RCA, all inspections on the live lane of level 1 roads require a spotter. The RCA may provide a list of roads, times and/or activities suitable for inspection by a single inspector
4. There must be CSD to the inspector when on the live lane. If this cannot be achieved, a spotter must be placed in a position where CSD can be attained and verbal instructions be given to the inspector. If this is not possible, a static or mobile operation is required.
5. Where an unaccompanied inspector is not able to maintain adequate attention (eg due to work tasks or poor visibility), a spotter will be required or another type of traffic management operation used
6. For inspection activities that are carried out by a TC on level LV and level 1 roads the STMS must be immediately contactable but does not have to be within 30 minutes travel time of the worksite
7. Inspectors MUST use 2 vehicles placed on either side of road shoulder. Inspector & spotter will use footpath to carry cones and cross when way is clear. Cones will be placed (min of 4 each direction) for protection. Spotter must not engage in work activities.

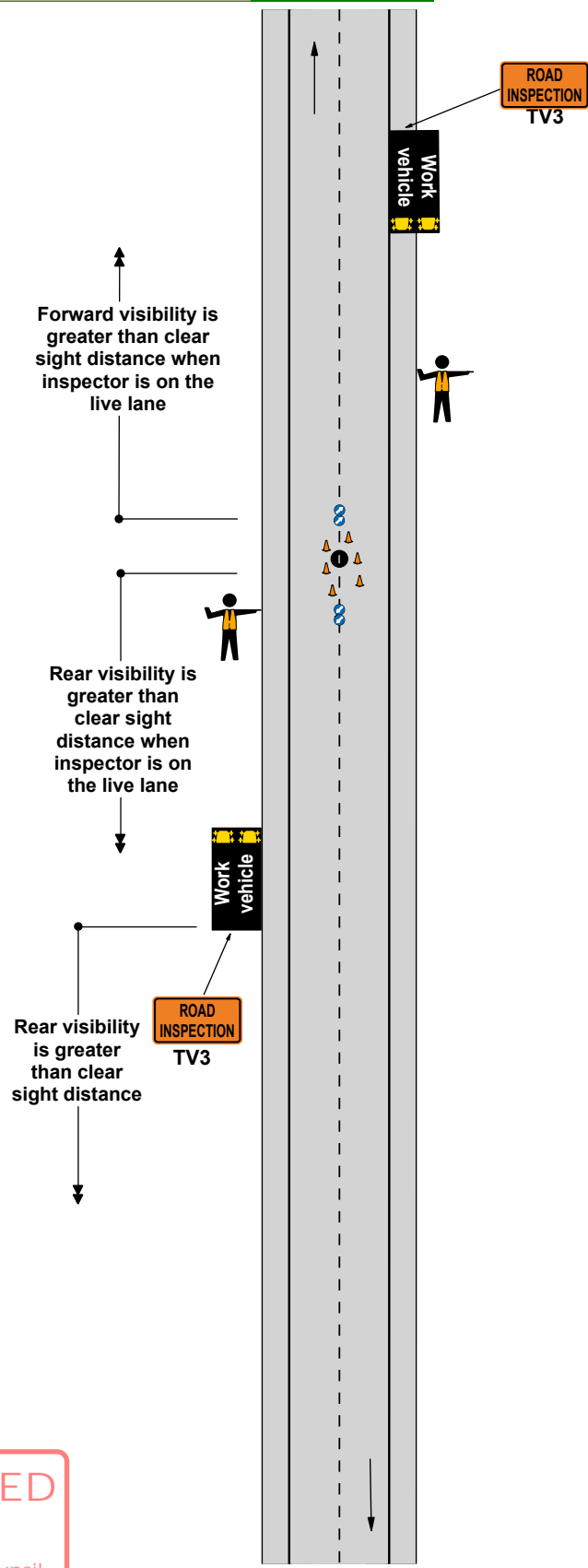

**APPROVED**

CAR R957162  
Jemal Dixon  
Wellington City Council

*[Signature]*

07 September 2023

**Static operations**

**TWO-WAY TWO-LANE ROAD**

**Cul De Sac - Closure**

**Access to maintained for Residents/Couriers/Emergency Services**

**ATMS08  
Level 1**

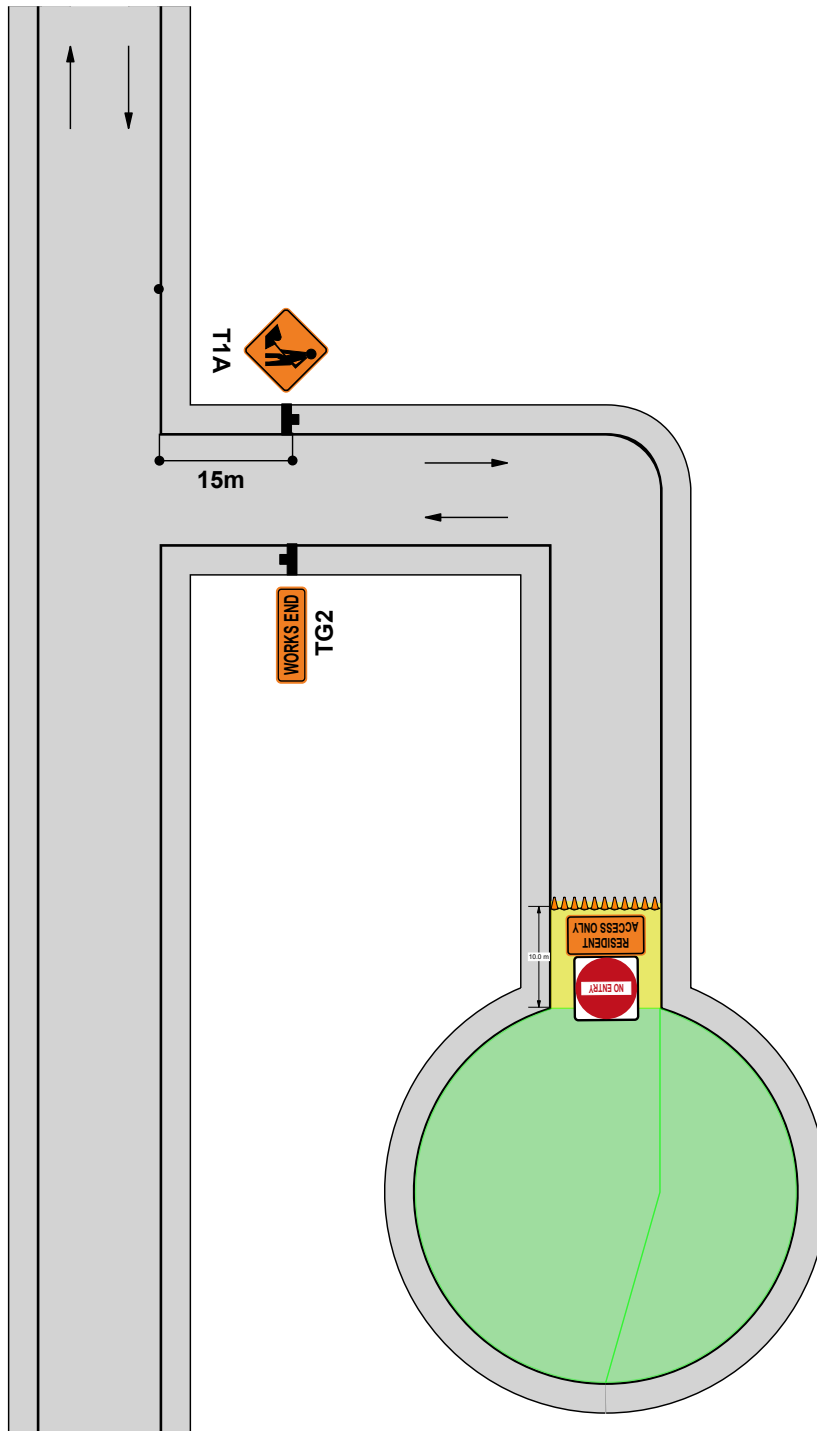

**APPROVED**  
CAR R957162  
Jemal Dixon  
Wellington City Council  
*Jemal Dixon*  
07 September 2023

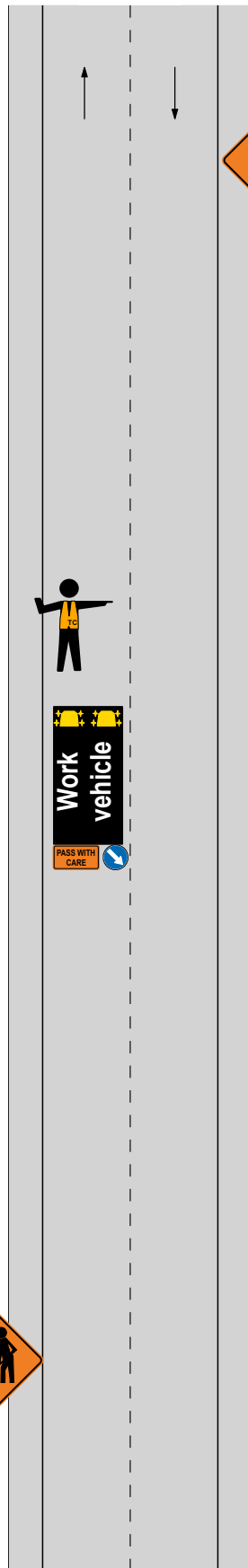

**Closure:** Level 1 Mobile Closure

**Level:** 1

**TMP Ref:** Mobile L1 - TTM Install/Removal

**APPROVED**

CAR R957162  
Jemal Dixon  
Wellington City Council

07 September 2023





## Main Roads List

Main Roads are the principal roads that connect the suburbs with each other, and connect the suburbs to the city. Main Roads also include many central city streets which get busy during peak traffic times. Streets which are part of the NZTA New Zealand State Highway Route from The Terrace tunnel to the Airport are also identified by **(State Highway)**. Streets which are part of the Over height route are identified in ***bold italics***.

Abel Smith St	Glasgow St	Onslow Rd
Adelaide Rd	Glenmore St	<i><b>Oriental Pde</b></i>
<i><b>Aotea Quay</b></i>	Grafton Rd	<i><b>Ottawa Rd</b></i>
Aro St	Grant Rd	Palliser Rd
Barnard St	Grey St	Panama St
Bassett Rd	Grosvenor Tce	Park St
Bay Rd	Hankey St	Paterson St <b>(State Highway)</b>
Bidwell St	Harriett St	<b>Highway)</b>
Birdwood St	Harris St	Perth St
Blackbridge Rd	Hataitai Rd	Raroa Cres
Boulcott St	Hawker St	Raroa Rd
Bowen St	Hawkestone St	Riddiford St
<i><b>Box Hill</b></i>	Helston Rd	Rintoul St
Bracken Rd	Hunter St	Rongotai Rd
Brandon St	<i><b>Hutt Rd</b></i>	Ruahine St <b>(State Highway)</b>
Britomart St	<i><b>Jervois Quay</b></i>	Rugby St <b>(State Highway)</b>
Broadway	John St	Salamanca Rd
Broderick Rd	Johnsonville Rd	Station Rd
Brooklyn Rd	Johnston St	Stout St
Brougham St	<i><b>Kaiwharawhara Rd</b></i>	Sussex St <b>(State Highway)</b>
Buckle St <b>(State Highway)</b>	Karo Dr <b>(State Highway)</b>	Takapu Rd
Buller St	Karori Rd	Tasman St
<i><b>Bunny St</b></i>	Kelburn Pde	Taranaki St <b>(State Highway)</b>
<i><b>Burma Rd</b></i>	Kent Tce <b>(State Highway)</b>	<b>Highway)</b>
<i><b>Cable St</b></i>	<i><b>Kenya St</b></i>	Taurima St <b>(State Highway)</b>
Calabar <b>(State Highway)</b>	<i><b>Khandallah Rd</b></i>	The Crescent
Cambridge Tce	Kilbirnie Cres	The Parade
Carlton Gore Rd	Kupe St	The Rigi
Cashmere Ave	Lambton Quay	The Terrace
Centennial Highway	Lennel Rd	<i><b>Thorndon Quay</b></i>
Chaffers St	Luxford St	Tinakori Rd
Chaytor St	MacDonald Cres	Troy St
Childers Tce	Maidavale Rd	Tory St
Churchill Dr	<i><b>Main Rd</b></i>	Upland Rd
Cobham Dr <b>(State Highway)</b>	Majoribanks St	<i><b>Victoria St</b></i>
<b>Highway)</b>	Manners St	Vivian St <b>(State Highway)</b>
<i><b>Cockayne Rd</b></i>	Mein St	Wadestown Rd
Constable St	<i><b>Mercer St</b></i>	Waikowhai St
Courtenay Pl	<i><b>Middleton Rd</b></i>	<i><b>Wakefield St</b></i>
Crawford Rd	Miramar Ave	Wallace St
<i><b>Crofton Rd</b></i>	Molesworth St	Waring Taylor St
Cuba St	<i><b>Moorefield Rd</b></i>	<i><b>Waterloo Quay</b></i>
Curtis St	Moxham Ave	Webb St
<i><b>Customhouse Quay</b></i>	Mulgrave St	Wellington Rd <b>(State Highway)</b>
Dixon St	Murphy St	<b>Highway)</b>
Dufferin St <b>(State Highway)</b>	Newlands Rd	Whitehead Rd
<b>Highway)</b>	<i><b>Ngaio Gorge Rd</b></i>	Whitmore St
Elizabeth St	Northland Rd	<i><b>Willeston St</b></i>
Ellice St <b>(State Highway)</b>	Ohiro Rd	<i><b>Willis St</b></i>
<i><b>Evans Bay Pde</b></i>	Old Karori Rd	<i><b>Willowbank Rd</b></i>
Featherston St	Onepu Rd	Wilton Rd
Garden Rd		
Ghuznee St		